



# 374

## Hydraulic Excavator

# Technical Specifications

Configurations and features may vary by region. Please consult your Cat® dealer for availability in your area.

### Table of Contents

<b>Specifications</b> .....	<b>2</b>
Engine .....	2
Swing Mechanism .....	2
Weights .....	2
Track .....	2
Drive .....	2
Air Conditioning System .....	2
Hydraulic System .....	2
Service Refill Capacity .....	2
Standards .....	3
Sound Performance .....	3
Operating Weights and Ground Pressures .....	3
Major Component Weights .....	4
Dimensions .....	5
Working Ranges and Forces .....	7
Reach Boom Lift Capacities .....	8
Mass Boom Lift Capacities .....	11
Bucket Specifications and Compatibility .....	17
Typical Pass Match Guide .....	18
Attachments Offering Guide .....	19
<b>Standard and Optional Equipment</b> .....	<b>21</b>
<b>Dealer Installed Kits and Attachments</b> .....	<b>23</b>
<b>Cab Options</b> .....	<b>24</b>
<b>374 Environmental Declaration</b> .....	<b>25</b>

# 374 Hydraulic Excavator Specifications

## Engine

Engine Model	Cat® C15	
Net Power – ISO 9249	361 kW	484 hp
Engine Power – ISO 14396	362 kW	485 hp
Bore	137 mm	5.39 in
Stroke	171 mm	6.73 in
Displacement	15.2 L	928 in <sup>3</sup>

- Meets U.S. EPA Tier 4 Final, EU Stage V, Korea Stage V, and Japan 2014 emission standards.
- Recommended for use up to 4500 m (14,760 ft) altitude with engine power derate above 3000 m (9,840 ft).
- Advertised power is tested per the specified standard in effect at the time of manufacture.
- Net power advertised is the power available at the flywheel when the engine is equipped with fan, air intake system, exhaust system and alternator.
- Engine speed at 1,700 rpm.
- Cat diesel engines are required to use ULSD (ultra-low sulfur diesel fuel with 15 ppm of sulfur or less) or ULSD blended with the following lower-carbon intensity fuels\*\* up to:
  - ✓ 20% biodiesel FAME (fatty acid methyl ester)\*
  - ✓ 100% renewable diesel, HVO (hydrotreated vegetable oil) and GTL (gas-to-liquid) fuels

Refer to guidelines for successful application. Please consult your Cat dealer or “Caterpillar Machine Fluids Recommendations” (SEBU6250) for details.

*\*Engines with no aftertreatment devices can use higher blends, up to 100% biodiesel (for use of blends higher than 20% biodiesel, consult your Cat dealer).*

*\*\*Tailpipe greenhouse gas emissions from lower-carbon intensity fuels are essentially the same as traditional fuels.*

## Swing Mechanism

Swing Speed	6.34 rpm	
Maximum Swing Torque	247 kN·m	182,200 lbf·ft

## Weights

Operating Weight	74 700 kg	164,700 lb
------------------	-----------	------------

- Long Variable Gauge undercarriage, Mass boom, M2.57WB (8'5") stick, XD 4.4 m<sup>3</sup> (5.75 yd<sup>3</sup>) bucket, 650 mm (26") HD double grouser shoes and standard counterweight.

## Track

Optional Track Shoes Width	650 mm	26 in
Optional Track Shoes Width	750 mm	30 in
Optional Track Shoes Width	900 mm	35 in
Number of Shoes (each side)	47	
Number of Track Rollers (each side)	8	
Number of Carrier Rollers (each side)	3	

## Drive

Maximum Gradeability	35°/70%	
Maximum Travel Speed	4.1 km/h	2.5 mph
Maximum Drawbar Pull	491 kN	110,359 lbf

## Air Conditioning System

The air conditioning system on this machine contains the fluorinated greenhouse gas refrigerant R134a (Global Warming Potential = 1430). The system contains 1.0 kg of refrigerant which, has a CO<sub>2</sub> equivalent of 1.430 metric tonnes.

## Hydraulic System

Main System – Maximum Flow – Implement	896 L/min (× 2 pumps)	237 gal/min (× 2 pumps)
Swing System – Maximum Flow	247 L/min	65 gal/min
Maximum Pressure – Equipment – Implement	37 000 kPa	5,366 psi
Maximum Pressure – Equipment – Lift Mode	38 000 kPa	5,511 psi
Maximum Pressure – Travel	35 000 kPa	5,076 psi
Maximum Pressure – Swing	35 000 kPa	5,076 psi
Boom Cylinder – Bore	190 mm	7 in
Boom Cylinder – Stroke	1792 mm	71 in
Stick Cylinder – Bore	210 mm	8 in
Stick Cylinder – Stroke	2118 mm	83 in
VB Bucket Cylinder – Bore	190 mm	7 in
VB Bucket Cylinder – Stroke	1433 mm	56 in
WB Bucket Cylinder – Bore	200 mm	8 in
WB Bucket Cylinder – Stroke	1457 mm	57 in

## Service Refill Capacity

Fuel Tank Capacity	920 L	243 gal
Cooling System	71 L	19 gal
Engine Oil (with filter)	62 L	16 gal
Swing Drive	20 L	5 gal
Final Drive (each)	32 L	9 gal
Hydraulic System (including tank)	620 L	164 gal
Hydraulic Tank (including suction pipe)	326 L	86 gal
Diesel Exhaust Fluid (DEF) Tank	80 L	21 gal

# 374 Hydraulic Excavator Specifications

## Standards

Brakes	ISO 10265:2008
Cab/ Operator Protective Guards (OPG) (optional)	ISO 10262:1998 Level II
Cab/Rollover Protective Structure (ROPS)	ISO 12117-2: 2008

## Sound Performance

ISO 6395:2008 (external)	108 dB(A)
ISO 6396:2008 (inside cab)	73 dB(A)

- Hearing protection may be needed when operating with an open operator station and cab (when not properly maintained or doors/windows open) for extended periods or in a noisy environment.

## Operating Weights and Ground Pressures

	650 mm (26") HD Double Grouser Shoes		750 mm (30") HD Double Grouser Shoes		900 mm (35") HD Double Grouser Shoes	
	Weight	Ground Pressure	Weight	Ground Pressure	Weight	Ground Pressure
	kg (lb)	kPa (psi)	kg (lb)	kPa (psi)	kg (lb)	kPa (psi)
<b>Base Machine Configurations</b>						
<b>Base Frame with Track Rollers and Carrier Rollers</b>						
<b>Standard Counterweight + Long Variable Gauge Undercarriage Base Machine</b>						
Reach Boom + R3.6VB (11'10") Stick + 3.3 m <sup>3</sup> (4.32 yd <sup>3</sup> ) SD bucket	71 700 (158,200)	115 (17)	72 400 (159,700)	100 (14)	73 400 (161,900)	83 (12)
Mass Boom + M3.0WB (9'10") Stick + 4.4 m <sup>3</sup> (5.75 yd <sup>3</sup> ) XD bucket	75 000 (165,300)	120 (17)	75 600 (166,700)	104 (15)	76 600 (169,000)	87 (13)
Mass Boom + M2.57WB (8'5") Stick + 4.4 m <sup>3</sup> (5.75 yd <sup>3</sup> ) XD bucket	74 700 (164,700)	120 (17)	75 400 (166,100)	104 (15)	76 400 (168,400)	86 (13)
<b>Removal Type Counterweight + Long Variable Gauge Undercarriage Base Machine</b>						
Reach Boom + R3.6VB (11'10") Stick + 3.3 m <sup>3</sup> (4.32 yd <sup>3</sup> ) SD bucket	71 800 (158,300)	115 (17)	72 500 (159,800)	101 (15)	73 500 (162,000)	85 (12)
Mass Boom + M3.0WB (9'10") Stick + 4.4 m <sup>3</sup> (5.75 yd <sup>3</sup> ) XD	75 000 (165,400)	120 (17)	75 700 (166,900)	105 (15)	76 700 (169,100)	89 (13)
Mass Boom + M2.57WB (8'5")Stick + 4.4 m <sup>3</sup> (5.75 yd <sup>3</sup> ) XD	74 800 (164,800)	120 (17)	75 400 (166,300)	105 (15)	76 400 (168,500)	89 (13)

All operating weights include a 90% fuel tank with 75 kg (165 lb) operator.

# 374 Hydraulic Excavator Specifications

## Major Component Weights

	kg	lb
Base Machine Weight: including upperframe, undercarriage, counterweight, boom cylinders, without boom, stick, bucket, stick cylinder, bucket cylinder, tracks, without fuel 612 kg (1,349 lb), operator 75 kg (165 lb), with hydraulic oil 184 kg (406 lb), diesel exhaust fluid 49 kg (108 lb)		
With Standard Counterweight, Swing Frame and Base Frame	48 030	105,880
With Removal Type Counterweight, Swing Frame and Base Frame	48 090	106,020
Track Shoes:		
650 mm (26") HD Double Grouser Track Shoes	8220	18,110
750 mm (30") HD Double Grouser Track Shoes	8890	19,600
900 mm (35") HD Double Grouser Track Shoes	9900	21,840
Two Boom Cylinders	2790	6,160
Weight of 90% Fuel Tank and 75 kg (165 lb) Operator	860	1,880
Counterweights:		
Standard Counterweight	11 240	24,770
Counterweight with Removal Device	11 300	24,910
Swing Frame:		
Standard Swing Frame	6450	14,210
Long Variable Gauge:		
Base Frame with Double Flange Track Rollers and Carrier Rollers	18 850	41,560
Booms (including lines, pins, stick cylinder):		
Reach Boom 7.8 m (25'7")	6960	15,330
Mass Boom 7.0 m (23'0")	7510	16,560
Sticks (including lines, pins, bucket cylinder, bucket linkage):		
Reach Stick R3.60VB (11'10")	3760	8,280
Mass Stick M3.0WB (9'10")	4400	9,710
Mass Stick M2.57WB (8'5")	4130	9,110
Buckets (without linkage):		
3.30 m <sup>3</sup> (4.32 yd <sup>3</sup> ) Severe Duty for VB	3940	8,680
4.40 m <sup>3</sup> (5.75 yd <sup>3</sup> ) Extreme Duty for WB	5950	13,110
Quick Couplers:		
CW Dedicated Quick Coupler for VB	1020	2,260
CW Dedicated Quick Coupler for WB	1080	2,370

# 374 Hydraulic Excavator Specifications

## Dimensions

All dimensions are approximate and may vary depending on bucket selection.

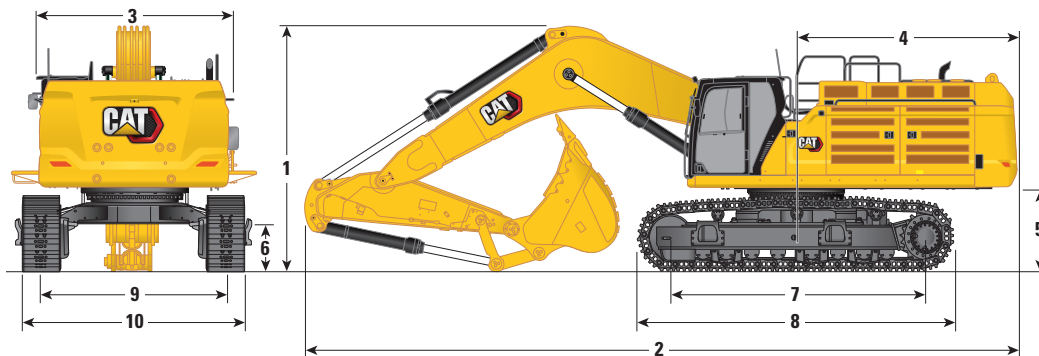

Boom Options	Reach Boom 7.8 m (25'7")		Mass Boom 7.0 m (23'0")			
	Reach Stick		Mass Stick			
Stick Options	R3.60VB (11'10")		M2.57WB (8'5")		M3.0WB (9'10")	
<b>1 Machine Height:</b>						
Cab Height	3559 mm	11'8"	3559 mm	11'8"	3559 mm	11'8"
OPG Height	3702 mm	12'1"	3702 mm	12'1"	3702 mm	12'1"
Handrails Height	3982 mm	13'0"	3982 mm	13'0"	3982 mm	13'0"
With Boom/Stick/Bucket Installed	4519 mm	14'9"	4927 mm	16'1"	4902 mm	16'0"
With Boom/Stick Installed	4287 mm	14'0"	4368 mm	14'3"	4463 mm	14'7"
With Boom Installed	3896 mm	12'9"	3896 mm	12'9"	3896 mm	12'9"
With Boom/Stick/Bucket Installed (with auxiliary lines)	4555 mm	14'11"	4942 mm	16'2"	4918 mm	16'1"
With Boom/Stick Installed (with auxiliary lines)	4319 mm	14'2"	4403 mm	14'5"	4496 mm	14'9"
With Boom Installed (with auxiliary lines)	4033 mm	13'2"	4033 mm	13'2"	4033 mm	13'2"
<b>2 Machine Length:</b>						
With Boom/Stick/Bucket Installed	13 652 mm	44'9"	12 978 mm	42'6"	12 856 mm	42'2"
With Boom/Stick Installed	13 625 mm	44'8"	12 719 mm	41'8"	12 702 mm	41'8"
With Boom Installed	11 855 mm	38'10"	11 011 mm	36'1"	11 011 mm	36'1"
With Boom/Stick/Bucket Installed (with auxiliary lines)	13 652 mm	44'9"	12 978 mm	42'6"	12 856 mm	42'2"
With Boom/Stick Installed (with auxiliary lines)	13 625 mm	44'8"	12 719 mm	41'8"	12 702 mm	41'8"
With Boom Installed (with auxiliary lines)	11 855 mm	38'10"	11 056 mm	36'3"	11 056 mm	36'3"
<b>3 Upperframe Width:</b>						
Without Walkways	3490 mm	11'5"	3490 mm	11'5"	3490 mm	11'5"
With Walkways	4508 mm	14'9"	4508 mm	14'9"	4508 mm	14'9"
Walkways Width	500 mm	1'7"	500 mm	1'7"	500 mm	1'7"
<b>4 Tail Swing Radius</b>	4171 mm	13'8"	4171 mm	13'8"	4171 mm	13'8"
<b>5 Counterweight Clearance (without shoe lug)</b>	1494 mm	4'10"	1494 mm	4'10"	1494 mm	4'10"
<b>6 Ground Clearance (without shoe lug)</b>	782 mm	2'6"	782 mm	2'6"	782 mm	2'6"

(continued on next page)

# 374 Hydraulic Excavator Specifications

## Dimensions (continued)

All dimensions are approximate and may vary depending on bucket selection.

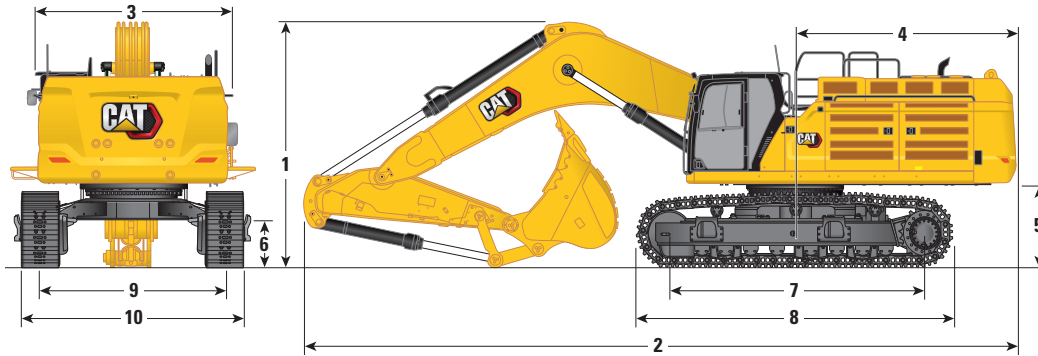

Boom Options	Reach Boom 7.8 m (25'7")		Mass Boom 7.0 m (23'0")			
Stick Options	Reach Stick		Mass Stick			
	R3.60VB (11'10")		M2.57WB (8'5")		M3.0WB (9'10")	
<b>7</b> Length to Center of Rollers	4705 mm	15'5"	4705 mm	15'5"	4705 mm	15'5"
<b>8</b> Track Length with Double Grouser Shoes	5873 mm	19'3"	5873 mm	19'3"	5873 mm	19'3"
<b>9</b> Track Gauge:						
Retracted with Double Grouser Shoes	2750 mm	9'0"	2750 mm	9'0"	2750 mm	9'0"
Extended with Double Grouser Shoes	3410 mm	11'2"	3410 mm	11'2"	3410 mm	11'2"
<b>10</b> Undercarriage Width – Retracted (without steps):						
650 mm (26") Shoes	3400 mm	11'1"	3400 mm	11'1"	3400 mm	11'1"
750 mm (30") Shoes	3500 mm	11'5"	3500 mm	11'5"	3500 mm	11'5"
900 mm (35") Shoes	3650 mm	11'11"	3650 mm	11'11"	3650 mm	11'11"
Undercarriage Width – Retracted (with steps):						
650 mm (26") Shoes	3678 mm	12'0"	3678 mm	12'0"	3678 mm	12'0"
750 mm (30") Shoes	3678 mm	12'0"	3678 mm	12'0"	3678 mm	12'0"
900 mm (35") Shoes	3678 mm	12'0"	3678 mm	12'0"	3678 mm	12'0"
Undercarriage Width – Extended (without steps):						
650 mm (26") Shoes	4060 mm	13'3"	4060 mm	13'3"	4060 mm	13'3"
750 mm (30") Shoes	4160 mm	13'7"	4160 mm	13'7"	4160 mm	13'7"
900 mm (35") Shoes	4310 mm	14'1"	4310 mm	14'1"	4310 mm	14'1"
Undercarriage Width – Extended (with steps):						
650 mm (26") Shoes	4338 mm	14'2"	4338 mm	14'2"	4338 mm	14'2"
750 mm (30") Shoes	4338 mm	14'2"	4338 mm	14'2"	4338 mm	14'2"
900 mm (35") Shoes	4338 mm	14'2"	4338 mm	14'2"	4338 mm	14'2"
Bucket Type:	SD		XD		XD	
Bucket Capacity	3.30 m <sup>3</sup>	4.32 yd <sup>3</sup>	4.40 m <sup>3</sup>	5.75 yd <sup>3</sup>	4.40 m <sup>3</sup>	5.75 yd <sup>3</sup>
Bucket Tip Radius	2240 mm	7'4"	2310 mm	7'6"	2310 mm	7'6"

# 374 Hydraulic Excavator Specifications

## Working Ranges and Forces

All dimensions are approximate and may vary depending on bucket selection.

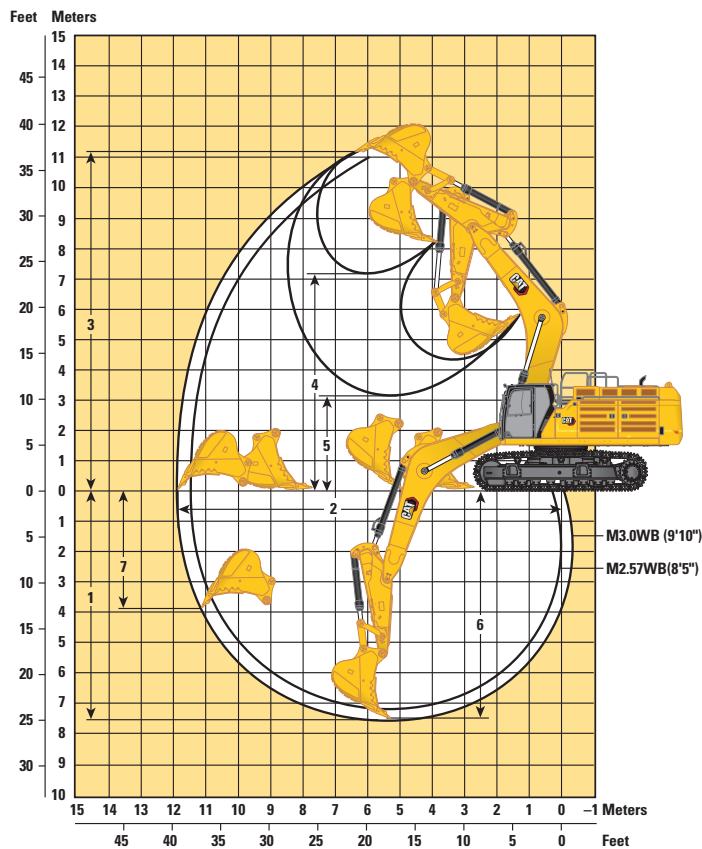
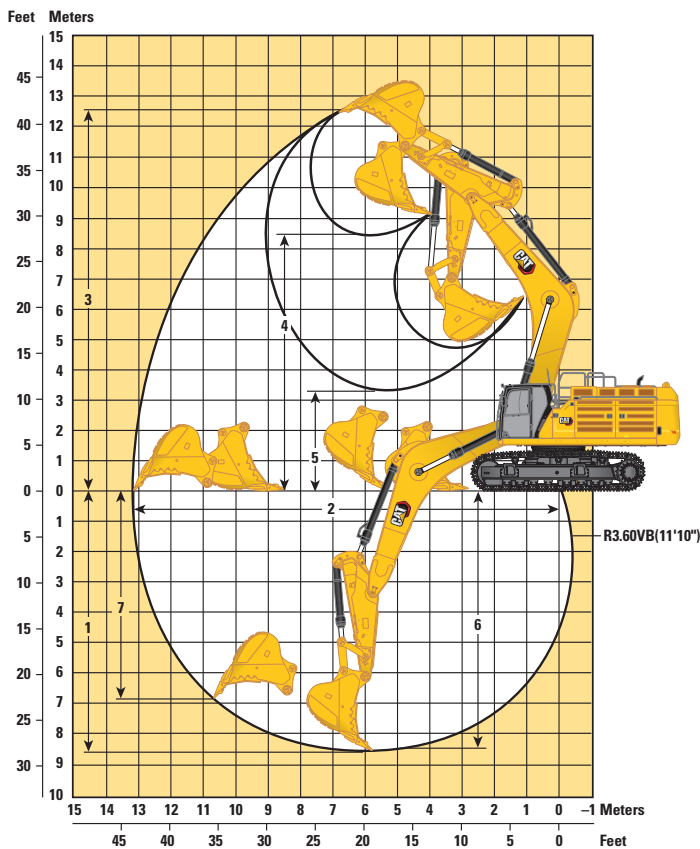

### Boom Options

**Reach Boom**  
7.8 m (25'7")

**Mass Boom**  
7.0 m (23'0")

### Stick Options

**Reach Stick**

**Mass Stick**

	R3.60VB (11'10")		M2.57WB (8'5")		M3.0WB (9'10")	
1 Maximum Digging Depth	8570 mm	28'1"	7240 mm	23'9"	7660 mm	25'1"
2 Maximum Reach at Ground Line	13 160 mm	43'2"	11 460 mm	37'7"	11 860 mm	38'10"
3 Maximum Cutting Height	12 550 mm	41'2"	11 000 mm	36'1"	11 170 mm	36'7"
4 Maximum Loading Height	8430 mm	27'7"	7050 mm	23'1"	7220 mm	23'8"
5 Minimum Loading Height	3310 mm	10'10"	3470 mm	11'4"	3050 mm	10'0"
6 Maximum Depth Cut for 2440 mm (8'0") Level Bottom	8440 mm	27'8"	7080 mm	23'2"	7520 mm	24'8"
7 Maximum Vertical Wall Digging Depth	6910 mm	22'8"	3620 mm	11'10"	3970 mm	13'0"
Bucket Digging Force (ISO)	358 kN	80,550 lbf	406 kN	91,230 lbf	406 kN	91,330 lbf
Stick Digging Force (ISO)	295 kN	66,390 lbf	352 kN	79,130 lbf	322 kN	72,450 lbf
Bucket Type	SD		XD		XD	
Bucket Capacity	3.30 m <sup>3</sup>	4.32 yd <sup>3</sup>	4.40 m <sup>3</sup>	5.75 yd <sup>3</sup>	4.40 m <sup>3</sup>	5.75 yd <sup>3</sup>
Bucket Tip Radius	2240 mm	7'4"	2310 mm	7'6"	2310 mm	7'6"

# 374 Hydraulic Excavator Specifications

## Reach Boom Lift Capacities – Standard Counterweight\*\* – without Bucket, Heavy Lift: On

Long Variable Gauge Undercarriage

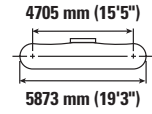
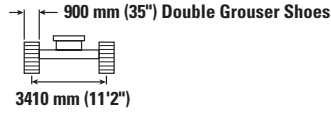
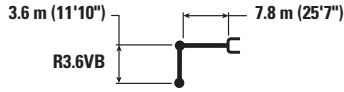

Reach Boom Lift Configuration	Unit	3000 mm/10'0"		4500 mm/15'0"		6000 mm/20'0"		7500 mm/25'0"		9000 mm/30'0"		10 500 mm/35'0"		mm ft/in		
		kg lb	kg lb	kg lb	kg lb	kg lb	kg lb	kg lb	kg lb	kg lb	kg lb	kg lb	kg lb	kg lb	mm ft/in	
10 500 mm 35'0"	kg lb													*16 150 *36,000	*16 150 *36,000	7760 24'10"
9000 mm 30'0"	kg lb									*15 700	15 250			*15 100 *33,400	15 050 *33,400	9070 29'4"
7500 mm 25'0"	kg lb							*16 950 *36,900	*16 950 *36,900	*15 750 *34,400	15 200 32,600			*14 650 *32,350	12 650 28,250	9980 32'6"
6000 mm 20'0"	kg lb					*21 500 *46,400	*21 500 *46,400	*18 300 *39,700	*18 300 *39,700	*16 350 *35,600	14 850 31,900	*15 200	11 450	*14 650 *32,250	11 250 25,000	10 610 34'8"
4500 mm 15'0"	kg lb					*24 750 *53,350	*24 750 *53,350	*20 050 *43,350	18 900 40,750	*17 250 *37,500	14 350 30,850	15 350 33,000	11 250 24,200	14 250 31,500	10 450 23,050	10 990 35'11"
3000 mm 10'0"	kg lb					*27 700 *59,750	24 850 53,600	*21 700 *46,950	18 000 38,850	*18 200 *39,500	13 850 29,800	15 050 32,400	11 000 23,600	13 750 30,250	10 000 22,050	11 150 36'6"
1500 mm 5'0"	kg lb					*29 400 *63,550	23 750 51,200	*22 900 *49,550	17 300 37,300	18 600 40,000	13 400 28,850	14 800 31,850	10 750 23,100	13 650 30,000	9900 21,750	11 110 36'5"
0 mm 0'0"	kg lb					*29 600 *64,150	23 200 49,950	*23 300 *50,500	16 850 36,300	18 250 39,300	13 100 28,200	14 650 31,500	10 550 22,750	13 950 30,750	10 100 22,250	10 860 35'7"
-1500 mm -5'0"	kg lb			*26 800 *61,450	*26 800 *61,450	*28 550 *61,950	23 050 49,600	*22 850 *49,450	16 650 35,850	18 100 39,000	12 950 27,900			14 850 32,700	10 700 23,600	10 390 34'0"
-3000 mm -10'0"	kg lb	*26 350 *59,550	*26 350 *59,550	*32 650 *70,900	*32 650 *70,900	*26 350 *57,000	23 200 49,900	*21 300 *45,950	16 700 35,950	*17 100 *36,700	13 000 28,050			*15 250 *33,550	11 900 26,300	9660 31'6"
-4500 mm -15'0"	kg lb	*32 400 *70,200	*32 400 *70,200	*27 450 *59,250	*27 450 *59,250	*22 550 *48,500	*22 550 *48,500	*18 100 *38,650	17 000 36,700					*14 650 *32,100	14 200 31,600	8600 27'11"
-6000 mm -20'0"	kg lb					*16 100 *33,600	*16 100 *33,600							*12 750 *27,600	*12 750 *27,600	7070 22'9"



ISO 10567:2007



\*Indicates that the load is limited by hydraulic lifting capacity rather than tipping load. The above loads are in compliance with hydraulic excavator lift capacity standard ISO 10567:2007. They do not exceed 87% of hydraulic lifting capacity or 75% of tipping load. Weight of all lifting accessories must be deducted from the above lifting capacities. Lifting capacities are based on the machine standing on a firm, uniform supporting surface. The use of a work tool attachment point to handle/lift objects, could affect the machine lift performance.

\*\*Lift capacities apply to both standard counterweight and counterweight with removal device.

Lift capacity stays with ±5% for all available track shoes.

Always refer to the appropriate Operation and Maintenance Manual for specific product information.

# 374 Hydraulic Excavator Specifications

## Reach Boom Lift Capacities – Standard Counterweight\*\* – without Bucket, Heavy Lift: On

Long Variable Gauge Undercarriage

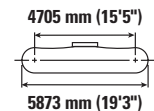
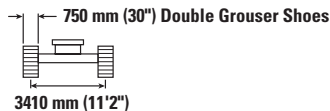
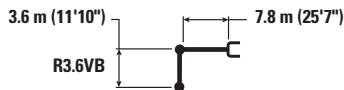

Reach Boom Length	Unit	3000 mm/10'0"		4500 mm/15'0"		6000 mm/20'0"		7500 mm/25'0"		9000 mm/30'0"		10 500 mm/35'0"		mm ft/in			
		kg	lb	kg	lb	kg	lb	kg	lb	kg	lb	kg	lb	kg	lb	mm	ft/in
10 500 mm 35'0"	kg													*16 150	*16 150	7760	
	lb													<b>*36,000</b>	<b>*36,000</b>	<b>24'10"</b>	
9000 mm 30'0"	kg									*15 700	15 050			*15 100	14 850	9070	
	lb									<b>*33,400</b>	<b>*33,400</b>			<b>*33,400</b>	<b>*33,400</b>	<b>29'4"</b>	
7500 mm 25'0"	kg							*16 950	*16 950	*15 750	15 000			*14 650	12 500	9980	
	lb							<b>*36,900</b>	<b>*36,900</b>	<b>*34,400</b>	<b>32,200</b>			<b>*32,350</b>	<b>27,850</b>	<b>32'6"</b>	
6000 mm 20'0"	kg					*21 500	*21 500	*18 300	*18 300	*16 350	14 650	*15 200	11 300	*14 650	11 100	10 610	
	lb					<b>*46,400</b>	<b>*46,400</b>	<b>*39,700</b>	<b>*39,700</b>	<b>*35,600</b>	<b>31,450</b>			<b>*32,250</b>	<b>24,650</b>	<b>34'8"</b>	
4500 mm 15'0"	kg					*24 750	*24 750	*20 050	18 650	*17 250	14 150	15 150	11 100	14 050	10 300	10 990	
	lb					<b>*53,350</b>	<b>*53,350</b>	<b>*43,350</b>	<b>40,200</b>	<b>*37,500</b>	<b>30,450</b>	<b>32,550</b>	<b>23,850</b>	<b>31,050</b>	<b>22,750</b>	<b>35'11"</b>	
3000 mm 10'0"	kg					*27 700	24 500	*21 700	17 750	*18 200	13 650	14 850	10 800	13 550	9850	11 150	
	lb					<b>*59,750</b>	<b>52,900</b>	<b>*46,950</b>	<b>38,300</b>	<b>*39,500</b>	<b>29,350</b>	<b>31,950</b>	<b>23,250</b>	<b>29,850</b>	<b>21,700</b>	<b>36'6"</b>	
1500 mm 5'0"	kg					*29 400	23 450	*22 900	17 050	18 300	13 200	14 600	10 550	13 450	9750	11 110	
	lb					<b>*63,550</b>	<b>50,450</b>	<b>*49,550</b>	<b>36,750</b>	<b>39,450</b>	<b>28,400</b>	<b>31,400</b>	<b>22,750</b>	<b>29,550</b>	<b>21,450</b>	<b>36'5"</b>	
0 mm 0'0"	kg					*29 600	22 900	*23 300	16 600	18 000	12 900	14 400	10 400	13 750	9950	10 860	
	lb					<b>*64,150</b>	<b>49,250</b>	<b>*50,500</b>	<b>35,800</b>	<b>38,700</b>	<b>27,750</b>	<b>31,050</b>	<b>22,450</b>	<b>30,300</b>	<b>21,900</b>	<b>35'7"</b>	
-1500 mm -5'0"	kg			*26 800	*26 800	*28 550	22 750	*22 850	16 400	17 850	12 750			14 600	10 550	10 390	
	lb			<b>*61,450</b>	<b>*61,450</b>	<b>*61,950</b>	<b>48,900</b>	<b>*49,450</b>	<b>35,350</b>	<b>38,400</b>	<b>27,450</b>			<b>32,250</b>	<b>23,250</b>	<b>34'0"</b>	
-3000 mm -10'0"	kg	*26 350	*26 350	*32 650	*32 650	*26 350	22 850	*21 300	16 450	*17 100	12 800			*15 250	11 700	9660	
	lb	<b>*59,550</b>	<b>*59,550</b>	<b>*70,900</b>	<b>*70,900</b>	<b>*57,000</b>	<b>49,200</b>	<b>*45,950</b>	<b>35,450</b>	<b>*36,700</b>	<b>27,650</b>			<b>*33,550</b>	<b>25,950</b>	<b>31'6"</b>	
-4500 mm -15'0"	kg	*32 400	*32 400	*27 450	*27 450	*22 550	*22 550	*18 100	16 750					*14 650	14 000	8600	
	lb	<b>*70,200</b>	<b>*70,200</b>	<b>*59,250</b>	<b>*59,250</b>	<b>*48,500</b>	<b>*48,500</b>	<b>*38,650</b>	<b>36,150</b>					<b>*32,100</b>	<b>31,150</b>	<b>27'11"</b>	
-6000 mm -20'0"	kg					*16 100	*16 100							*12 750	*12 750	7070	
	lb					<b>*33,600</b>	<b>*33,600</b>							<b>*27,600</b>	<b>*27,600</b>	<b>22'9"</b>	



ISO 10567:2007



\*Indicates that the load is limited by hydraulic lifting capacity rather than tipping load. The above loads are in compliance with hydraulic excavator lift capacity standard ISO 10567:2007. They do not exceed 87% of hydraulic lifting capacity or 75% of tipping load. Weight of all lifting accessories must be deducted from the above lifting capacities. Lifting capacities are based on the machine standing on a firm, uniform supporting surface. The use of a work tool attachment point to handle/lift objects, could affect the machine lift performance.

\*\*Lift capacities apply to both standard counterweight and counterweight with removal device.

Lift capacity stays with ±5% for all available track shoes.

Always refer to the appropriate Operation and Maintenance Manual for specific product information.

# 374 Hydraulic Excavator Specifications

## Reach Boom Lift Capacities – Standard Counterweight\*\* – without Bucket, Heavy Lift: On

Long Variable Gauge Undercarriage

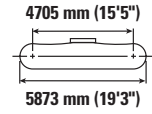
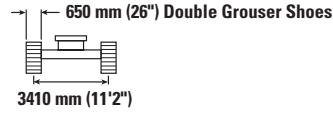
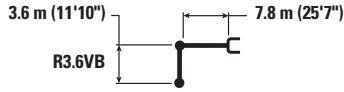

Reach mm ft/in	kg lb	3000 mm/10'0"		4500 mm/15'0"		6000 mm/20'0"		7500 mm/25'0"		9000 mm/30'0"		10 500 mm/35'0"		mm ft/in		
10 500 mm 35'0"	kg lb													*16 150 *36,000	*16 150 *36,000	7760 24'10"
9000 mm 30'0"	kg lb									*15 700	14 950			*15 100 *33,400	14 750 33,100	9070 29'4"
7500 mm 25'0"	kg lb							*16 950 *36,900	*16 950 *36,900	*15 750 *34,400	14 850 31,900			*14 650 *32,350	12 400 27,600	9980 32'6"
6000 mm 20'0"	kg lb					*21 500 *46,400	*21 500 *46,400	*18 300 *39,700	*18 300 *39,700	*16 350 *35,600	14 500 31,200	*15 200	11 200	*14 650 *32,250	11 000 24,400	10 610 34'8"
4500 mm 15'0"	kg lb					*24 750 *53,350	*24 750 *53,350	*20 050 *43,350	18 500 39,850	*17 250 *37,500	14 000 30,150	15 000 32,200	11 000 23,600	13 950 30,750	10 200 22,500	10 990 35'11"
3000 mm 10'0"	kg lb					*27 700 *59,750	24 300 52,400	*21 700 *46,950	17 600 37,950	*18 200 *39,500	13 500 29,100	14 700 31,650	10 700 23,050	13 400 29,550	9750 21,500	11 150 36'6"
1500 mm 5'0"	kg lb					*29 400 *63,550	23 200 50,000	*22 900 *49,550	16 900 36,400	18 150 39,050	13 050 28,150	14 450 31,100	10 450 22,500	13 300 29,250	9650 21,200	11 110 36'5"
0 mm 0'0"	kg lb					*29 600 *64,150	22 650 48,750	*23 300 *50,200	16 450 35,400	17 800 38,350	12 750 27,450	14 250 30,750	10 300 22,200	13 600 30,000	9850 21,650	10 860 35'7"
-1500 mm -5'0"	kg lb					*26 800 *61,450	*26 800 *61,450	*28 550 *61,950	22 500 48,400	*22 850 *49,450	16 250 35,000	17 650 38,000	12 600 27,200	14 450 31,900	10 450 23,000	10 390 34'0"
-3000 mm -10'0"	kg lb	*26 350 *59,550	*26 350 *59,550	*32 650 *70,900	*32 650 *70,900	*26 350 *57,000	22 650 48,700	*21 300 *45,950	16 300 35,100	*17 100 *36,700	12 700 27,350			*15 250 *33,550	11 600 25,650	9660 31'6"
-4500 mm -15'0"	kg lb	*32 400 *70,200	*32 400 *70,200	*27 450 *59,250	*27 450 *59,250	*22 550 *48,500	*22 550 *48,500	*18 100 *38,650	16 600 35,800					*14 650 *32,100	13 850 30,850	8600 27'11"
-6000 mm -20'0"	kg lb					*16 100 *33,600	*16 100 *33,600							*12 750 *27,600	*12 750 *27,600	7070 22'9"



ISO 10567:2007



\*Indicates that the load is limited by hydraulic lifting capacity rather than tipping load. The above loads are in compliance with hydraulic excavator lift capacity standard ISO 10567:2007. They do not exceed 87% of hydraulic lifting capacity or 75% of tipping load. Weight of all lifting accessories must be deducted from the above lifting capacities. Lifting capacities are based on the machine standing on a firm, uniform supporting surface. The use of a work tool attachment point to handle/lift objects, could affect the machine lift performance.

\*\*Lift capacities apply to both standard counterweight and counterweight with removal device.

Lift capacity stays with ±5% for all available track shoes.

Always refer to the appropriate Operation and Maintenance Manual for specific product information.

# 374 Hydraulic Excavator Specifications

## Mass Boom Lift Capacities – Standard Counterweight\*\* – without Bucket, Heavy Lift: On

Long Variable Gauge Undercarriage

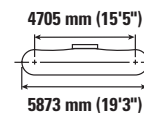
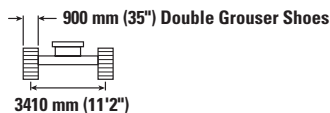

Boom Length	Unit	3000 mm/10'0"		4500 mm/15'0"		6000 mm/20'0"		7500 mm/25'0"		9000 mm/30'0"		mm ft/in		
		kg lb	kg lb	kg lb	kg lb	kg lb	kg lb	kg lb	kg lb	kg lb	kg lb	kg lb	kg lb	
9000 mm 30'0"	kg lb											*15 100 *33,500	*15 100 *33,500	7350 23'7"
7500 mm 25'0"	kg lb							*17 800 *39,000	*17 800 *39,000			*14 300 *31,550	*14 300 *31,550	8450 27'5"
6000 mm 20'0"	kg lb					*21 400 *46,300	*21 400 *46,300	*18 650 *40,600	*18 650 *40,600	*17 200 14 350		*14 100 *31,050	*13 850 30,800	9180 29'11"
4500 mm 15'0"	kg lb			*33 250 *71,100	*33 250 *71,100	*24 350 *52,550	*24 350 *52,550	*20 100 *43,550	18 700 40,300	*17 700 *38,550	14 000 30,100	*14 350 *31,550	12 550 27,700	9620 31'6"
3000 mm 10'0"	kg lb					*27 200 *58,700	24 850 53,600	*21 600 *46,800	17 850 38,450	*18 400 *39,900	13 550 29,200	*15 000 *32,950	11 850 26,150	9810 32'1"
1500 mm 5'0"	kg lb					*28 950 *62,650	23 700 51,050	*22 700 *49,150	17 150 36,950	18 450 39,650	13 200 28,350	*16 150 *35,550	11 700 25,800	9760 32'0"
0 mm 0'0"	kg lb			*31 750 *73,600	*31 750 *73,600	*29 250 *63,350	23 150 49,750	*23 000 *49,800	16 700 36,000	18 150 39,100	12 950 27,850	16 900 37,200	12 050 26,550	9480 31'0"
-1500 mm -5'0"	kg lb	*26 150 *59,100	*26 150 *59,100	*36 050 *78,350	*36 050 *78,350	*28 000 *60,700	23 000 49,450	*22 150 *47,900	16 550 35,700			*17 650 *38,850	13 100 28,900	8930 29'2"
-3000 mm -10'0"	kg lb	*38 850 *84,650	*38 850 *84,650	*31 650 *68,600	*31 650 *68,600	*25 100 *54,200	23 250 50,000	*19 550 *41,850	16 800 36,200			*17 400 *38,250	15 300 33,900	8060 26'3"
-4500 mm -15'0"	kg lb			*24 550 *52,550	*24 550 *52,550	*19 250 *40,750	*19 250 *40,750					*16 100 *35,250	*16 100 *35,250	6750 21'10"



ISO 10567:2007



\*Indicates that the load is limited by hydraulic lifting capacity rather than tipping load. The above loads are in compliance with hydraulic excavator lift capacity standard ISO 10567:2007. They do not exceed 87% of hydraulic lifting capacity or 75% of tipping load. Weight of all lifting accessories must be deducted from the above lifting capacities. Lifting capacities are based on the machine standing on a firm, uniform supporting surface. The use of a work tool attachment point to handle/lift objects, could affect the machine lift performance.

\*\*Lift capacities apply to both standard counterweight and counterweight with removal device.

Lift capacity stays with ±5% for all available track shoes.



Always refer to the appropriate Operation and Maintenance Manual for specific product information.

# 374 Hydraulic Excavator Specifications

## Mass Boom Lift Capacities – Standard Counterweight\*\* – without Bucket, Heavy Lift: On

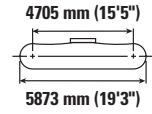
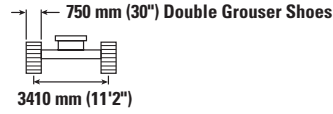
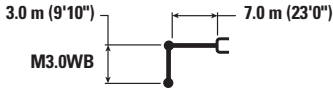
Long Variable Gauge Undercarriage



	3000 mm/10'0"		4500 mm/15'0"		6000 mm/20'0"		7500 mm/25'0"		9000 mm/30'0"				mm ft/in	
	kg lb	kg lb	kg lb	kg lb	kg lb	kg lb	kg lb	kg lb	kg lb	kg lb	kg lb	kg lb		
9000 mm 30'0"												*15 100 *33,500	*15 100 *33,500	7350 23'7"
7500 mm 25'0"							*17 800 *39,000	*17 800 *39,000				*14 300 *31,550	*14 300 *31,550	8450 27'5"
6000 mm 20'0"					*21 400 *46,300	*21 400 *46,300	*18 650 *40,600	*18 650 *40,600	*17 200	14 150		*14 100 *31,050	*13 650 30,350	9180 29'11"
4500 mm 15'0"			*33 250 *71,100	*33 250 *71,100	*24 350 *52,550	*24 350 *52,550	*20 100 *43,550	18 450 39,750	*17 700 *38,550	13 800 29,700		*14 350 *31,550	12 350 27,300	9620 31'6"
3000 mm 10'0"					*27 200 *58,700	24 500 52,850	*21 600 *46,800	17 600 37,950	*18 400 *39,900	13 350 28,750		*15 000 *32,950	11 700 25,750	9810 32'1"
1500 mm 5'0"					*28 950 *62,650	23 350 50,350	*22 700 *49,150	16 900 36,400	18 150 39,050	13 000 27,950		16 100 35,400	11 550 25,400	9760 32'0"
0 mm 0'0"			*31 750 *73,600	*31 750 *73,600	*29 250 *63,350	22 800 49,050	*23 000 *49,800	16 450 35,450	17 900 38,550	12 750 27,450		16 650 36,650	11 900 26,150	9480 31'0"
-1500 mm -5'0"		*26 150 *59,100	*26 150 *59,100	*36 050 *78,350	*36 050 *78,050	*28 000 *60,700	22 650 48,700	*22 150 *47,900	16 300 35,150			*17 650 *38,850	12 900 28,450	8930 29'2"
-3000 mm -10'0"		*38 850 *84,650	*38 850 *84,650	*31 650 *68,600	*31 650 *68,600	*25 100 *54,200	22 900 49,250	*19 550 *41,850	16 550 35,700			*17 400 *38,250	15 050 33,400	8060 26'3"
-4500 mm -15'0"				*24 550 *52,550	*24 550 *52,550	*19 250 *40,750	*19 250 *40,750					*16 100 *35,250	*16 100 *35,250	6750 21'10"



ISO 10567:2007



\*Indicates that the load is limited by hydraulic lifting capacity rather than tipping load. The above loads are in compliance with hydraulic excavator lift capacity standard ISO 10567:2007. They do not exceed 87% of hydraulic lifting capacity or 75% of tipping load. Weight of all lifting accessories must be deducted from the above lifting capacities. Lifting capacities are based on the machine standing on a firm, uniform supporting surface. The use of a work tool attachment point to handle/lift objects, could affect the machine lift performance.

\*\*Lift capacities apply to both standard counterweight and counterweight with removal device.

Lift capacity stays with ±5% for all available track shoes.

Always refer to the appropriate Operation and Maintenance Manual for specific product information.

# 374 Hydraulic Excavator Specifications

## Mass Boom Lift Capacities – Standard Counterweight\*\* – without Bucket, Heavy Lift: On

Long Variable Gauge Undercarriage

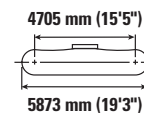
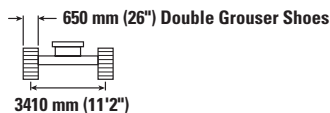

		3000 mm/10'0"		4500 mm/15'0"		6000 mm/20'0"		7500 mm/25'0"		9000 mm/30'0"		mm ft/in		
9000 mm 30'0"	kg lb											*15 100 *33,500	*15 100 *33,500	7350 23'7"
7500 mm 25'0"	kg lb							*17 800 *39,000	*17 800 *39,000			*14 300 *31,550	*14 300 *31,550	8450 27'5"
6000 mm 20'0"	kg lb					*21 400 *46,300	*21 400 *46,300	*18 650 *40,600	*18 650 *40,600	*17 200 14 050		*14 100 *31,050	*13 550 30,050	9180 29'11"
4500 mm 15'0"	kg lb			*33 250 *71,100	*33 250 *71,100	*24 350 *52,550	*24 350 *52,550	*20 100 *43,550	18 300 39,400	*17 700 *38,550	13 700 29,400	*14 350 *31,550	12 250 27,050	9620 31'6"
3000 mm 10'0"	kg lb					*27 200 *58,700	24 300 52,400	*21 600 *46,800	17 450 37,550	*18 400 39,550	13 250 28,500	*15 000 *32,950	11 550 25,500	9810 32'1"
1500 mm 5'0"	kg lb					*28 950 *62,650	23 150 49,850	*22 700 *49,150	16 750 36,050	18 000 38,700	12 850 27,650	15 900 35,050	11 400 25,150	9760 32'0"
0 mm 0'0"	kg lb			*31 750 *73,600	*31 750 *73,600	*29 250 *63,350	22 550 48,550	*23 000 *49,800	16 300 35,100	17 700 38,150	12 600 27,150	16 450 36,300	11 750 25,900	9480 31'0"
-1500 mm -5'0"	kg lb	*26 150 *59,100	*26 150 *59,100	*36 050 *78,350	*36 050 *77,300	*28 000 *60,700	22 450 48,250	*22 150 *47,900	16 150 34,800			*17 650 *38,850	12 750 28,150	8930 29'2"
-3000 mm -10'0"	kg lb	*38 850 *84,650	*38 850 *84,650	*31 650 *68,600	*31 650 *68,600	*25 100 *54,200	22 650 48,800	*19 550 *41,850	16 350 35,350			*17 400 *38,250	14 900 33,050	8060 26'3"
-4500 mm -15'0"	kg lb			*24 550 *52,550	*24 550 *52,550	*19 250 *40,750	*19 250 *40,750					*16 100 *35,250	*16 100 *35,250	6750 21'10"



ISO 10567:2007



\*Indicates that the load is limited by hydraulic lifting capacity rather than tipping load. The above loads are in compliance with hydraulic excavator lift capacity standard ISO 10567:2007. They do not exceed 87% of hydraulic lifting capacity or 75% of tipping load. Weight of all lifting accessories must be deducted from the above lifting capacities. Lifting capacities are based on the machine standing on a firm, uniform supporting surface. The use of a work tool attachment point to handle/lift objects, could affect the machine lift performance.

\*\*Lift capacities apply to both standard counterweight and counterweight with removal device.

Lift capacity stays with ±5% for all available track shoes.

Always refer to the appropriate Operation and Maintenance Manual for specific product information.

# 374 Hydraulic Excavator Specifications

## Mass Boom Lift Capacities – Standard Counterweight\*\* – without Bucket, Heavy Lift: On

Long Variable Gauge Undercarriage

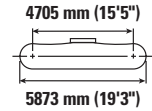
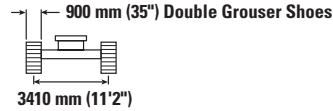
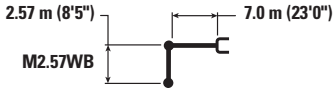

Boom Length	Unit	3000 mm/10'0"		4500 mm/15'0"		6000 mm/20'0"		7500 mm/25'0"		9000 mm/30'0"		mm ft/in		
		kg lb	kg lb	kg lb	kg lb	kg lb	kg lb	kg lb	kg lb	kg lb	kg lb	kg lb	mm ft/in	
9000 mm 30'0"	kg lb											*18 150 *40,350	*18 150 *40,350	6820 21'10"
7500 mm 25'0"	kg lb							*18 850 *41,450	*18 850 *41,450			*17 100 *37,750	*17 100 *37,750	8000 25'11"
6000 mm 20'0"	kg lb					*22 600 *48,900	*22 600 *48,900	*19 550 *42,600	19 400 41,750			*16 850 *37,100	14 950 33,200	8770 28'7"
4500 mm 15'0"	kg lb					*25 450 *54,950	*25 450 *54,950	*20 900 *45,300	18 650 40,150	*18 400 *40,100	14 000 30,100	*17 150 *37,750	13 450 29,700	9230 30'2"
3000 mm 10'0"	kg lb					*28 100 *60,650	24 700 53,250	*22 250 *48,150	17 850 38,450	18 900 40,650	13 600 29,300	17 600 38,800	12 700 28,000	9430 30'10"
1500 mm 5'0"	kg lb					*29 450 *63,750	23 700 51,050	*23 100 *50,100	17 200 37,100	18 550 39,900	13 300 28,650	17 450 38,450	12 550 27,650	9380 30'9"
0 mm 0'0"	kg lb			*29 500 *69,100	*29 500 *69,100	*29 300 *63,500	23 250 50,050	*23 150 *50,100	16 850 36,300	18 350 40,000	13 150 28,600	18 150 40,000	13 000 28,600	9080 29'9"
-1500 mm -5'0"	kg lb		*60,300	*34 600 *75,450	*34 600 *75,450	*27 600 *59,850	23 250 50,000	*21 900 *47,300	16 800 36,200			*18 450 *40,650	14 250 31,400	8500 27'10"
-3000 mm -10'0"	kg lb	*34 200 *74,750	*34 200 *74,750	*29 800 *64,700	*29 800 *64,700	*24 100 *51,950	23 600 50,800	*18 350	17 200			*17 950 *39,500	16 950 37,600	7590 24'9"
-4500 mm -15'0"	kg lb			*21 750 *46,400	*21 750 *46,400	*16 700	*16 700					*15 900 *34,600	*15 900 *34,600	6170 19'11"



ISO 10567:2007



\*Indicates that the load is limited by hydraulic lifting capacity rather than tipping load. The above loads are in compliance with hydraulic excavator lift capacity standard ISO 10567:2007. They do not exceed 87% of hydraulic lifting capacity or 75% of tipping load. Weight of all lifting accessories must be deducted from the above lifting capacities. Lifting capacities are based on the machine standing on a firm, uniform supporting surface. The use of a work tool attachment point to handle/lift objects, could affect the machine lift performance.

\*\*Lift capacities apply to both standard counterweight and counterweight with removal device.

Lift capacity stays with ±5% for all available track shoes.

Always refer to the appropriate Operation and Maintenance Manual for specific product information.

# 374 Hydraulic Excavator Specifications

## Mass Boom Lift Capacities – Standard Counterweight\*\* – without Bucket, Heavy Lift: On

Long Variable Gauge Undercarriage

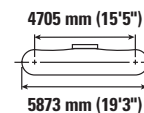
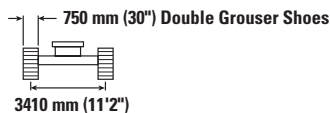

Boom Length	Unit	3000 mm/10'0"		4500 mm/15'0"		6000 mm/20'0"		7500 mm/25'0"		9000 mm/30'0"		mm ft/in		
		kg lb	kg lb	kg lb	kg lb	kg lb	kg lb	kg lb	kg lb	kg lb	kg lb	kg lb	kg lb	
9000 mm 30'0"	kg lb											*18 150 *40,350	*18 150 *40,350	6820 21'10"
7500 mm 25'0"	kg lb							*18 850 *41,450	*18 850 *41,450			*17 100 *37,750	*17 100 *37,750	8000 25'11"
6000 mm 20'0"	kg lb					*22 600 *48,900	*22 600 *48,900	*19 550 *42,600	19 150 41,250			*16 850 *37,100	14 750 32,750	8770 28'7"
4500 mm 15'0"	kg lb					*25 450 *54,950	*25 450 *54,950	*20 900 *45,300	18 400 39,600	*18 400 *40,100	13 800 29,650	*17 150 *37,750	13 250 29,300	9230 30'2"
3000 mm 10'0"	kg lb					*28 100 *60,650	24 350 52,500	*22 250 *48,150	17 600 37,900	18 600 40,050	13 450 28,900	17 350 38,250	12 500 27,600	9430 30'10"
1500 mm 5'0"	kg lb					*29 450 *63,750	23 350 50,350	*23 100 *50,100	16 950 36,550	18 250 39,300	13 100 28,200	17 200 37,900	12 350 27,200	9380 30'9"
0 mm 0'0"	kg lb			*29 500 *69,100	*29 500 *69,100	*29 300 *63,500	22 950 49,350	*23 150 *50,100	16 600 35,800	18 100	12 950	17 900 39,400	12 800 28,200	9080 29'9"
-1500 mm -5'0"	kg lb	*60,300	*60,300	*34 600 *75,450	*34 600 *75,450	*27 600 *59,850	22 900 49,300	*21 900 *47,300	16 550 35,700			*18 450 *40,650	14 050 30,950	8500 27'10"
-3000 mm -10'0"	kg lb	*34 200 *74,750	*34 200 *74,750	*29 800 *64,700	*29 800 *64,700	*24 100 *51,950	23 250 50,050	*18 350	16 950			*17 950 *39,500	16 700 37,050	7590 24'9"
-4500 mm -15'0"	kg lb			*21 750 *46,400	*21 750 *46,400	*16 700	*16 700					*15 900 *34,600	*15 900 *34,600	6170 19'11"



ISO 10567:2007



\*Indicates that the load is limited by hydraulic lifting capacity rather than tipping load. The above loads are in compliance with hydraulic excavator lift capacity standard ISO 10567:2007. They do not exceed 87% of hydraulic lifting capacity or 75% of tipping load. Weight of all lifting accessories must be deducted from the above lifting capacities. Lifting capacities are based on the machine standing on a firm, uniform supporting surface. The use of a work tool attachment point to handle/lift objects, could affect the machine lift performance.

\*\*Lift capacities apply to both standard counterweight and counterweight with removal device.

Lift capacity stays with ±5% for all available track shoes.

Always refer to the appropriate Operation and Maintenance Manual for specific product information.

# 374 Hydraulic Excavator Specifications

## Mass Boom Lift Capacities – Standard Counterweight\*\* – without Bucket, Heavy Lift: On

Long Variable Gauge Undercarriage

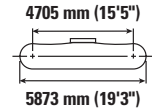
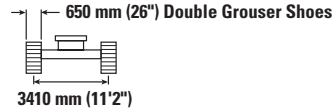
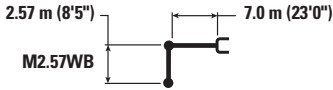

Boom Length	Unit	3000 mm/10'0"		4500 mm/15'0"		6000 mm/20'0"		7500 mm/25'0"		9000 mm/30'0"		mm ft/in		
		kg lb	kg lb	kg lb	kg lb	kg lb	kg lb	kg lb	kg lb	kg lb	kg lb	kg lb	mm ft/in	
9000 mm 30'0"	kg lb											*18 150 *40,350	*18 150 *40,350	6820 21'10"
7500 mm 25'0"	kg lb							*18 850 *41,450	*18 850 *41,450			*17 100 *37,750	*17 100 *37,750	8000 25'11"
6000 mm 20'0"	kg lb					*22 600 *48,900	*22 600 *48,900	*19 550 *42,600	19 000 40,850			*16 850 *37,100	14 600 32,450	8770 28'7"
4500 mm 15'0"	kg lb					*25 450 *54,950	*25 450 *54,950	*20 900 *45,300	18 200 39,250	*18 400 *40,100	13 700 29,400	*17 150 *37,750	13 150 29,000	9230 30'2"
3000 mm 10'0"	kg lb					*28 100 *60,650	24 150 52,050	*22 250 *48,150	17 450 37,550	18 450 39,650	13 300 28,600	17 150 37,850	12 400 27,300	9430 30'10"
1500 mm 5'0"	kg lb					*29 450 *63,750	23 150 49,850	*23 100 *50,100	16 800 36,200	18 100 38,950	12 950 27,950	17 050 37,500	12 250 26,950	9380 30'9"
0 mm 0'0"	kg lb			*29 500 *69,100	*29 500 *69,100	*29 300 *63,500	22 700 48,850	*23 150 *50,100	16 450 35,450	17 900	12 800	17 700 39,000	12 650 27,900	9080 29'9"
-1500 mm -5'0"	kg lb		*60,300	*34 600 *75,450	*34 600 *75,450	*27 600 *59,850	22 700 48,800	*21 900 *47,300	16 400 35,350			*18 450 *40,650	13 900 30,650	8500 27'10"
-3000 mm -10'0"	kg lb	*34 200 *74,750	*34 200 *74,750	*29 800 *64,700	*29 800 *64,700	*24 100 *51,950	23 050 49,600	*18 350	16 750			*17 950 *39,500	16 550 36,700	7590 24'9"
-4500 mm -15'0"	kg lb			*21 750 *46,400	*21 750 *46,400	*16 700	*16 700					*15 900 *34,600	*15 900 *34,600	6170 19'11"



ISO 10567:2007



\*Indicates that the load is limited by hydraulic lifting capacity rather than tipping load. The above loads are in compliance with hydraulic excavator lift capacity standard ISO 10567:2007. They do not exceed 87% of hydraulic lifting capacity or 75% of tipping load. Weight of all lifting accessories must be deducted from the above lifting capacities. Lifting capacities are based on the machine standing on a firm, uniform supporting surface. The use of a work tool attachment point to handle/lift objects, could affect the machine lift performance.

\*\*Lift capacities apply to both standard counterweight and counterweight with removal device.

Lift capacity stays with ±5% for all available track shoes.

Always refer to the appropriate Operation and Maintenance Manual for specific product information.

# 374 Hydraulic Excavator Specifications

## Bucket Specifications and Compatibility\*

	Width		Capacity		Weight		Fill	Long Variable Gauge Undercarriage					
								11.24 mt (24,770 lb) Counterweight			11.3 mt (24,910 lb) Counterweight with Removal Device		
	mm	in	m <sup>3</sup>	yd <sup>3</sup>	kg	lb	%	Reach Boom 7.8 m (25'7")	Mass Boom 7.0 m (23'0")		Reach Boom 7.8 m (25'7")	Mass Boom 7.0 m (23'0")	
								R3.6 m (11'10")	M2.57 m (8'5")	M3.0 m (9'10")	R3.6 m (11'10")	M2.57 m (8'5")	M3.0 m (9'10")
<b>No Coupler</b>													
General Duty	2000	79	3.80	4.97	3649	8,045	100	⊖			⊖		
Heavy Duty	2000	79	3.80	4.97	3810	8,400	100	⊖			⊖		
General Duty	2150	85	5.00	6.54	4164	9,180	100		⊙	⊖		⊙	⊙
Heavy Duty	2150	85	5.00	6.54	4340	9,569	100		⊙	⊖		⊙	⊖
Severe Duty Spade	1950	77	4.10	5.36	4821	10,629	90		●	●		●	●
	2050	81	4.40	5.75	4977	10,973	90		●	⊙		●	⊙
	2150	85	4.60	6.02	5134	11,319	90		●	⊙		●	⊙
	2250	89	5.00	6.54	5291	11,665	90		⊙	⊖		⊙	⊖
Extreme Duty Spade	2050	81	4.40	5.75	5768	12,717	90		●	⊙		●	⊙
	2150	85	4.60	6.02	5955	13,129	90		⊙	⊖		⊙	⊖
	2250	89	5.00	6.54	6139	13,535	90		⊖	⊖		⊙	⊖
	Maximum load with pin-on (payload + bucket)							kg	10 034	13 797	12 678	10 071	13 845
							lb	22,123	30,413	27,955	22,201	30,523	28,043
<b>With Cat Pin Grabber Coupler</b>													
General Duty	2000	79	3.80	4.97	3649	8,045	100	○			○		
Heavy Duty	2000	79	3.80	4.97	3810	8,400	100	○			○		
Maximum load with coupler (payload + bucket)							kg	8640			8677		
							lb	19,048			19,130		
<b>With CW-70</b>													
Severe Duty Spade	1950	77	4.00	5.23	4795	10,572	90		●	⊙		●	⊙
	2050	81	4.40	5.75	4950	10,913	90		⊙	⊖		⊙	⊖
Extreme Duty Spade	2050	81	4.40	5.75	5551	12,238	90		⊙	⊖		⊙	⊖
Maximum load with coupler (payload + bucket)							kg		12 517	11 398		12 565	11 443
							lb		27,595	25,128		27,701	25,228

\*Matches apply to both standard counterweight and counterweight with removal device.

The above loads are in compliance with hydraulic excavator standard EN474-5:2006 + A3:2013, they do not exceed 87% of hydraulic lifting capacity or 75% of tipping capacity with front linkage fully extended at ground line with bucket curled.

Capacity based on ISO 7451:2007.

Bucket weight with General Duty tips.

### Maximum Material Density:

- 2100 kg/m<sup>3</sup> (3,500 lb/yd<sup>3</sup>)
- ⊙ 1800 kg/m<sup>3</sup> (3,000 lb/yd<sup>3</sup>)
- ⊖ 1500 kg/m<sup>3</sup> (2,500 lb/yd<sup>3</sup>)
- 1200 kg/m<sup>3</sup> (2,000 lb/yd<sup>3</sup>)

Caterpillar recommends using appropriate work tools to maximize the value customers receive from our products. Use of work tools, including buckets, which are outside of Caterpillar's recommendations or specifications for weight, dimensions, flows, pressures, etc. may result in less-than-optimal performance, including but not limited to reductions in production, stability, reliability, and component durability. Improper use of a work tool resulting in sweeping, prying, twisting and/or catching of heavy loads will reduce the life of the boom and stick.

# 374 Hydraulic Excavator Specifications

## Typical Pass Match Guide

For maximum production and efficiency, we recommend that loading and hauling machines are matched to achieve optimal performance.

### Configuration\*:

Long Variable Gauge undercarriage, Mass boom, M2.57WB (8'5") stick, XD 4.4 m<sup>3</sup> (5.75 yd<sup>3</sup>) bucket, 650 mm (26") HD double grouser shoes and standard counterweight.

### Passes Required to Fill Trucks to Rated Capacity

Material Type	Material Density	Cat Articulated Trucks							Cat Off-Highway Trucks			
		725	730 EJ	730	735	740 GC	740 EJ	745	770G	772G	773E	773G
Earth	1600 kg/m <sup>3</sup> (2,700 lb/yd <sup>3</sup> )		4	4	4-5	5	5-6	6	5-6	6-7	8	8
Limestone	1540 kg/m <sup>3</sup> (2,600 lb/yd <sup>3</sup> )	4	4-5	4-5	5	6	6	7	6	8		

\*The indicated pass match reflects the machine configuration, fill factor, and typical material density shown. Changes to machine configurations, fill factors, or material density as well as jobsite-specific factors may influence exact pass match recommendations for your application. Consult your Cat dealer for more information.

# 374 Hydraulic Excavator Specifications

## Attachments Offering Guide

Not all attachments are available in all regions. Consult your Cat dealer for configurations available in your region.

Match    
  Working range front only    
  No Match    
  1800 kg/m<sup>3</sup> (3,000 lb/yd<sup>3</sup>)    
  1200 kg/m<sup>3</sup> (2,000 lb/yd<sup>3</sup>)

### PIN-ON ATTACHMENTS

Undercarriage		Long Variable Gauge			Long Variable Gauge		
Counterweight		11.3 mt (24,910 lb) with Removal Device			11.24 mt (24,770 lb)		
Boom Type		Reach HD	Mass	Mass	Reach HD	Mass	Mass
Stick Length		3.6 m HD (11'10")	2.57 m (8'5")	3.0 m (9'10")	3.6 m HD (11'10")	2.57 m (8'5")	3.0 m (9'10")
Hydraulic Hammers	H180 S	✓	✓	✓	✓	✓	✓
	H190 S	✓	✓	✓	✓	✓	✓
	H215 S	✓	✓	✓	✓	✓	✓
Multi-Processors	MP365 Concrete Cutter Jaw	✓	✓	✓	✓	✓	✓
	MP365 Concrete Cutter Jaw-Flat Top	✓					
	MP365 Demolition Jaw	✓	✓	✓	✓	✓	✓
	MP365 Demolition Jaw-Flat Top	✓					
	MP365 Pulverizer Jaw	✓	✓	✓	✓	✓	✓
	MP365 Pulverizer Jaw-Flat Top	✓					
	MP365 Shear Jaw	✓	✓	✓	✓	✓	✓
	MP365 Shear Jaw-Flat Top	✓					
Mobile Scrap and Demolition Shears	S3070 Flat Top	✓	✓	✓	✓	✓	✓
Pulverizers	P245 Secondary Pulverizer	✓			✓		
	P365 Primary Pulverizer	✓	✓	✓	✓	✓	✓
	P365 Primary Pulverizer-Flat Top	✓			✓		
Orange Peel Grapples	GSM-60-3750		○	○		○	○
Clamshell Grapples	CTV40-3500	○	●	●	○	●	●
	CTV40-4000	○	●	○	○	●	○
	CTV40-4500		○	○		○	○
	CTV40-5000		○	○		○	○

### CAT PIN GRABBER COUPLER ATTACHMENTS

Undercarriage		Long Variable Gauge			Long Variable Gauge		
Counterweight		11.3 mt (24,910 lb) with Removal Device			11.24 mt (24,770 lb)		
Boom Type		Reach HD			Reach HD		
Stick Length		3.6 m HD (11'10")			3.6 m HD (11'10")		
Hydraulic Hammers	H180 S		✓			✓	
	H190 S		✓			✓	
	H215 S		✓*			✓*	
Multi-Processors	MP365 Concrete Cutter Jaw		✓			✓	
	MP365 Concrete Cutter Jaw-Flat Top		✓				
	MP365 Demolition Jaw		✓			✓	
	MP365 Demolition Jaw-Flat Top		✓*				
	MP365 Pulverizer Jaw		✓			✓	
	MP365 Pulverizer Jaw-Flat top		✓*				
	MP365 Shear Jaw		✓			✓	
	MP365 Shear Jaw-Flat Top		✓*				
Pulverizers	P245 Secondary Pulverizer		✓			✓	
	P365 Primary Pulverizer		✓			✓	

(continued on next page)

# 374 Hydraulic Excavator Specifications

## Attachments Offering Guide (continued)

Not all attachments are available in all regions. Consult your Cat dealer for configurations available in your region.

Match       Working range front only       No Match

### CW-70 DEDICATED COUPLER ATTACHMENTS

Undercarriage		Long Variable Gauge			Long Variable Gauge		
		11.3 mt (24,910 lb) with Removal Device			11.24 mt (24,770 lb)		
Counterweight							
Boom Type		Reach HD	Mass	Mass	Reach HD	Mass	Mass
Stick Length		3.6 m HD (11'10")	2.57 m (8'5")	3.0 m (9'10")	3.6 m HD (11'10")	2.57 m (8'5")	3.0 m (9'10")
Hydraulic Hammers	H180 S	✓	✓	✓	✓	✓	✓
	H190 S	✓	✓	✓	✓	✓	✓
	H215 S	✓*	✓	✓	✓*	✓	✓
Multi-Processors	MP365 Concrete Cutter Jaw	✓	✓	✓	✓	✓	✓
	MP365 Concrete Cutter Jaw-Flat Top	✓	✓	✓			
	MP365 Demolition Jaw	✓	✓	✓	✓	✓	✓
	MP365 Demolition Jaw-Flat Top	✓*	✓	✓			
	MP365 Pulverizer Jaw	✓	✓	✓	✓	✓	✓
	MP365 Pulverizer Jaw-Flat Top	✓*	✓	✓			
	MP365 Shear Jaw	✓	✓	✓	✓	✓	✓
	MP365 Shear Jaw-Flat Top	✓	✓	✓			
Mobile Scrap and Demolition Shears	S3070 Flat Top		✓	✓		✓	✓
Pulverizers	P365 Primary Pulverizer	✓	✓	✓	✓	✓	✓
	P365 Primary Pulverizer-Flat Top	✓*	✓	✓	✓*	✓	✓

### BOOM-MOUNT ATTACHMENTS

Undercarriage		Long Variable Gauge			Long Variable Gauge	
		11.3 mt (24,910 lb) with Removal Device			11.24 mt (24,770 lb)	
Counterweight						
Boom Type		Reach HD	Mass	Reach HD	Mass	
Mobile Scrap and Demolition Shears	S2090	✓	✓	✓	✓	

## Standard and Optional Equipment

Standard and optional equipment may vary. Consult your Cat dealer for details.

	Standard	Optional		Standard	Optional
<b>BOOMS, STICKS AND LINKAGES</b>			<b>ELECTRICAL SYSTEM</b>		
7.0 m (23'0") Mass boom		✓	Maintenance-free 1,400 CCA batteries (×2)	✓	
7.8 m (25'7") Reach boom		✓	Centralized electrical disconnect switch	✓	
2.57 m (8'5") Mass stick		✓	Chassis light	✓	
3.00 m (9'10") Mass stick		✓	LED boom and cab lights		✓
3.60 m (11'10") Reach stick		✓	Exterior lights (integrated into storage box)	✓	
Bucket Linkage, VB family with lifting eye, Cat Grade		✓	<b>ENGINE</b>		
Bucket Linkage, VB family without lifting eye, Cat Grade		✓	Cold start block heater		✓
Bucket Linkage, WB family with lifting eye, Cat Grade		✓	Three selectable modes: Power, Smart, Eco	✓	
Bucket Linkage, WB family without lifting eye, Cat Grade		✓	Automatic engine speed control	✓	
<b>CAT TECHNOLOGY</b>			Up to 4500 m (14,764 ft) altitude capability	✓	
VisionLink®	✓*		52° C (126° F) high-ambient cooling capacity	✓	
VisionLink Productivity		✓	-18° C (0° F) cold start capability	✓	
Remote Flash	✓		-32° C (-25° F) cold start capability		✓
Remote Troubleshoot	✓		Hydraulic reverse fan	✓	
Operator Coaching	✓		Double element filter with integrated pre-cleaner air filter	✓	
Cat Grade Connectivity		✓	Three vertical side-by-side cooling system	✓	
Compatibility with radios and base stations from Trimble, Topcon, and Leica	✓		95 Amp alternator	✓	
Capability to install 3D grade systems from Trimble, Topcon, and Leica	✓		<i>(continued on next page)</i>		
Cat Grade 2D	✓				
Cat Grade 2D with Attachment Ready Option (ARO)		✓			
Cat Grade 3D single GNSS		✓			
Cat Grade 3D dual GNSS		✓			
Laser catcher		✓			
Cat Assist:	✓				
– Grade Assist					
– Boom Assist					
– Bucket Assist					
– Swing Assist					
– Lift Assist					
Cat Payload:	✓				
– Static weigh					
– Semiautomatic calibration					
– Payload/cycle information					
– USB reporting capability					
Work tool recognition (PL161)	✓				
Work tool tracking (PL161)	✓				
Cat Tilt Rotator (TRS) Integration		✓			

\*Connect subscription only. Additional subscriptions are available. Contact your Cat dealer for availability.

# 374 Standard and Optional Equipment

## Standard and Optional Equipment (continued)

Standard and optional equipment may vary. Consult your Cat dealer for details.

	Standard	Optional		Standard	Optional
<b>HYDRAULIC SYSTEM</b>			<b>SERVICE AND MAINTENANCE</b>		
SmartBoom™		✓	Integrated vehicle health management system	✓	
Boom and stick regeneration circuit	✓		Auto lube ready	✓	
Electronic main control valve	✓		Grouped location for engine oil and fuel filters	✓	
Dedicated closed loop swing circuit	✓		Scheduled Oil Sampling (S·O·S <sup>SM</sup> ) ports	✓	
Auto heavy lift	✓		QuickEvac™ maintenance ready	✓	
Automatic hydraulic oil warmup	✓		Electric refueling pump with auto shutoff		✓
Automatic swing parking brake	✓		<b>UNDERCARRIAGE AND STRUCTURES</b>		
High performance hydraulic return filter	✓		Long variable gauge undercarriage	✓	
Two speed travel	✓		Towing eye on base frame	✓	
Bio hydraulic oil and filter	✓		Three-piece segmented track guiding guards		✓
Advanced tool control		✓	Two-piece full-length track guiding guards		✓
Medium-pressure auxiliary circuit		✓	Swivel guard	✓	
Quick coupler circuit		✓	Grease lubricated track	✓	
Hydraulic efficiency monitoring		✓	Standard counterweight	✓	
<b>SAFETY AND SECURITY</b>			Counterweight with removal device		✓
Cat Command (remote control)		✓	650 mm (26") HD double grouser track shoes		✓
Caterpillar One Key security system	✓		750 mm (30") HD double grouser track shoes		✓
2D E-Fence:	✓		900 mm (35") HD double grouser track shoes		✓
– E-ceiling			HD bottom guard	✓	
– E-floor			HD travel motor guard	✓	
– E-swing					
– E-wall					
– E-cab avoidance					
Auto hammer stop	✓				
Lockable external tool/storage box	✓				
Lockable door, fuel, and hydraulic tank locks	✓				
Lockable fuel drain compartment	✓				
Service platforms with anti-skid plate	✓				
Lockable disconnect switch	✓				
Right-hand handrail and handhold	✓				
Standard visibility mirror package	✓				
Signaling/warning horn	✓				
Travel alarm		✓			
Swing alarm		✓			
Ground-level secondary engine shutoff switch	✓				
Rear and right-hand-sideview cameras	✓				
360° visibility		✓			
Boom lowering check valve		✓			
Stick lowering check valve		✓			
Walkway	✓				
Tilt-up walkway		✓			
Inspection lighting		✓			

## Dealer Installed Kits and Attachments

Attachments may vary. Consult your Cat dealer for details.

### CAB

- Radial lower wiper
- Joystick with horizontal sliders
- Left Hand (LH)/Right Hand (RH) electrical pedal for tool control
- Dual exit rear window kit
- Front windshield laminated glass (P5A glass, EU demolition regulation)

### ELECTRICAL

- LED premium lights, 1,200 lumens on chassis, 850 lumens on boom and cab

### ELECTRICAL

- 1,800 lumen LED premium surround lights

### SAFETY AND SECURITY

- Bluetooth® key fob
- 76 mm (3") retractable seat belt
- Cat Command – Remote control kit

### GUARDS

- OPG (not compatible with cab light cover, rain protector)
- Mesh guard full front (not compatible with cab light cover, rain protector)
- Mesh guard lower half front
- Full protecting vandalism guard
- Rain protector for front windshield plus cab light cover

### OTHER ATTACHMENTS

- GNSS antennae

# 374 Cab Options

## Cab Options

	Deluxe	Premium
Sound suppressed cab with viscount mounts	●	●
High-resolution 254 mm (10") LCD touch screen monitor	●	●
Additional high-resolution LCD touch screen monitor for Cat Grade 2D and 3D	○	○
Automatic bi-level air conditioner	●	●
Jog dial and shortcut keys for monitor control	●	●
Keyless push-to-start engine control	●	●
Height-adjustable console, infinite with no tool	●	●
Tilt-up left-side console	●	●
Cat Stick Steer	○	○
Auxiliary relay	○	○
Heated seat with air-adjustable suspension	●	X
Heated and cooled seat with automatic adjustable suspension	X	●
51 mm (2") orange seat belt	●	●
Bluetooth integrated radio (including USB, aux port and microphone)	●	●
2 × 12V DC outlets	●	●
Document storage	●	●
Rear head storage net and lunchbox storage net	●	●
Cup and bottle holders	●	●
Fixed one-piece windshield	X	○
Openable two-piece front window	●	○
Upper radial wiper with washer	●	X
Parallel wiper with washer	X	●
Openable polycarbonate skylight hatch	●	○
Fixed glass laminated skylight	X	○
LED dome light	●	●
Floor welcome light	●	●
Roller front sunscreen	●	●
Roller rear sunscreen	○	●
Rear window emergency exit	●	●
Washable floor mat	●	●
Beacon ready	●	●

● Standard

○ Optional

X Not available

The following information applies to the machine at the time of final manufacture as configured for sale in the regions covered in this document. The content of this declaration is valid as of the date issued; however, content related to machine features and specifications are subject to change without notice. For additional information, please see the machine's Operation and Maintenance Manual.

For more information on sustainability in action and our progress, please visit <https://www.caterpillar.com/en/company/sustainability>.

## Engine

- The Cat® C15 engine meets U.S. EPA Tier 4 Final, EU Stage V, Korea Stage V, and Japan 2014 emission standards.
- Cat diesel engines are required to use ULSD (ultra-low sulfur diesel fuel with 15 ppm of sulfur or less) or ULSD blended with the following lower-carbon intensity fuels\*\* up to:
  - ✓ 20% biodiesel FAME (fatty acid methyl ester)\*
  - ✓ 100% renewable diesel, HVO (hydrotreated vegetable oil) and GTL (gas-to-liquid) fuels

Refer to guidelines for successful application. Please consult your Cat dealer or “Caterpillar Machine Fluids Recommendations” (SEBU6250) for details.

*\*Engines with no aftertreatment devices can use higher blends, up to 100% biodiesel (for use of blends higher than 20% biodiesel, consult your Cat dealer).*

*\*\*Tailpipe greenhouse gas emissions from lower-carbon intensity fuels are essentially the same as traditional fuels.*

## Air Conditioning System

- The air conditioning system on this machine contains the fluorinated greenhouse gas refrigerant R134a (Global Warming Potential = 1430). The system contains 1.0 kg (2.2 lb) of refrigerant which has a CO<sub>2</sub> equivalent of 1.430 metric tonnes (1.576 tons).

## Paint

- Based on best available knowledge, the maximum allowable concentration, measured in parts per million (PPM), of the following heavy metals in paint are:
  - Barium < 0.01%
  - Cadmium < 0.01%
  - Chromium < 0.01%
  - Lead < 0.01%

## Sound Performance

ISO 6395:2008 (external) – 108 dB(A)

ISO 6396:2008 (inside cab) – 73 dB(A)

- Hearing protection may be needed when operating with an open operator station and cab (when not properly maintained or doors/windows open) for extended periods or in a noisy environment.

## Oils and Fluids

- Caterpillar factory fills with ethylene glycol coolants. Cat Diesel Engine Antifreeze/Coolant (DEAC) and Cat Extended Life Coolant (ELC) can be recycled. Consult your Cat dealer for more information.
- Cat Bio HYDO™ Advanced is an EU Ecolabel approved biodegradable hydraulic oil.
- Additional fluids are likely to be present, please consult the Operations and Maintenance Manual or the Application and Installation guide for complete fluid recommendations and maintenance intervals.

## Features and Technology

- The following features and technology may contribute to fuel savings and/or carbon reduction. Features may vary. Consult your Cat dealer for details.
  - Smart mode matches machine power to digging requirements automatically
  - Eco mode minimizes fuel consumption for light applications
  - Standard Cat technologies boost productivity and improve operator efficiency by up to 45%
  - Hydraulic oil filter provides longer life with a 3,000-hour replacement interval – 50% longer than previous filter designs
  - Cut costs with extended maintenance intervals

For more complete information on Cat products, dealer services, and industry solutions, visit us on the web at [www.cat.com](http://www.cat.com)

© 2023 Caterpillar  
All rights reserved

Materials and specifications are subject to change without notice. Featured machines in photos may include additional equipment. See your Cat dealer for available options.

CAT, CATERPILLAR, LET'S DO THE WORK, their respective logos, "Caterpillar Corporate Yellow," the "Power Edge" and Cat "Modern Hex" trade dress as well as corporate and product identity used herein, are trademarks of Caterpillar and may not be used without permission. VisionLink is a trademark of Caterpillar Inc., registered in the United States and in other countries.

AEXQ2895-05 (12-2023)  
AEXQ2895-04  
Build Number: 07D  
(Europe)

