



335

Hydraulic Excavator

Technical Specifications

Configurations and features may vary by region. Please consult your Cat® dealer for availability in your area.

Table of Contents

Specifications	2
Engine	2
Swing Mechanism	2
Weights	2
Track	2
Drive	2
Hydraulic System	3
Service Refill Capacities	3
Air Conditioning System	3
Standards	3
Sound Performance	3
Operating Weights and Ground Pressures	4
Major Component Weights	4
Dimensions	5
Working Ranges and Forces	6
Blade Dimensions	7
Reach Boom Lift Capacities	8
Bucket Specifications and Compatibility:	
North America	26
Europe	29
Australia and New Zealand	34
Hong Kong and Taiwan	35
Attachments Offering Guide:	
North America	36
Europe	45
Australia and New Zealand	58
Hong Kong and Taiwan	60
Standard and Optional Equipment	61
Dealer Installed Kits and Attachments	63
Cab Options	64
335 Environmental Declaration	65

335 Hydraulic Excavator Specifications

Engine

Engine Model	Cat® C7.1	
Net Power		
ISO 9249	203.7 kW	273 hp
ISO 9249 (DIN)	277 hp (metric)	
Engine Power		
ISO 14396	205 kW	275 hp
ISO 14396 (DIN)	279 hp (metric)	
Bore	105 mm	4 in
Stroke	135 mm	5 in
Displacement	7.01 L	428 in ³
Biodiesel Capability	Up to B20 ⁽¹⁾	

- Meets U.S. EPA Tier 4 Final and EU Stage V emission standards.
- No engine power derating required below 3,000 m (9,840 ft) altitude. 4600 m (15,090 ft) altitude with engine power derate.
- Advertised power is tested per the specified standard in effect at the time of manufacture.
- Net power advertised is the power available at the flywheel when the engine is equipped with fan, air intake system, exhaust system and alternator.
- Engine speed at 2,200 rpm.

⁽¹⁾Cat diesel engines are required to use ULSD (ultra-low sulfur diesel fuel with 15 ppm of sulfur or less) or ULSD blended with the following lower-carbon intensity fuels** up to:

- ✓ 20% biodiesel FAME (fatty acid methyl ester)*
- ✓ 100% renewable diesel, HVO (hydrogenated vegetable oil) and GTL (gas-to-liquid) fuels

Refer to guidelines for successful application. Please consult your Cat dealer or “Caterpillar Machine Fluids Recommendations” (SEBU6250) for details.

**Engines with no aftertreatment devices can use higher blends, up to 100% biodiesel (for use of blends higher than 20% biodiesel, consult your Cat dealer).*

***Tailpipe greenhouse gas emissions from lower-carbon intensity fuels are essentially the same as traditional fuels.*

Swing Mechanism

Swing Speed*	10.8 rpm	
Maximum Swing Torque	107.7 kN·m	79,455 lbf·ft

*For CE-marked machine default value may be set lower.

Weights

Operating Weight	36 200 kg	79,900 lb
• Long undercarriage Reach boom, R3.2 (10'6") stick, HD 1.54 m ³ (2.01 yd ³) bucket, 850 mm (33") triple grouser shoes and 7.7 mt (16,980 lb) counterweight.		
Operating Weight	36 300 kg	80,000 lb
• Long undercarriage Reach boom, R3.2 (10'6") stick, HD 1.54 m ³ (2.01 yd ³) bucket, 850 mm (33") triple grouser shoes, 5.0 mt (11,202 lb) counterweight and 3600 mm (11'10") blade.		
Operating Weight	35 000 kg	77,200 lb
• Long undercarriage Reach boom, R3.2 (10'6") stick, HD 1.54 m ³ (2.01 yd ³) bucket, 600 mm (24") triple grouser shoes and 7.7 mt (16,980 lb) counterweight.		
Operating Weight	34 900 kg	77,000 lb
• Long undercarriage Reach boom, R3.2 (10'6") stick, HD 1.54 m ³ (2.01 yd ³) bucket, 600 mm (24") triple grouser shoes, 5.0 mt (11,202 lb) counterweight and 3440 mm (11'3") blade.		

Track

Optional Track Shoes Width	600 mm	24 in
Optional Track Shoes Width	700 mm	28 in
Optional Track Shoes Width	850 mm	33 in
Number of Shoes (each side)	49	
Number of Track Rollers (each side)	8	
Number of Carrier Rollers (each side)	2	

Drive

Maximum Gradeability	35°/70%	
Maximum Travel Speed	4.7 km/h	2.9 mph
Maximum Drawbar Pull	303 kN	68,117 lbf

335 Hydraulic Excavator Specifications

Hydraulic System

Main System – Maximum Flow – Implement	560 L/min (280 × 2 pumps)	148 gal/min (74 × 2 pumps)
Maximum Pressure – Equipment – Normal	35 000 kPa	5,075 psi
Maximum Pressure – Equipment – Heavy Lift Mode/Auto Dig Boost	38 000 kPa	5,510 psi
Maximum Pressure – Travel	35 000 kPa	5,075 psi
Maximum Pressure – Swing	28 800 kPa	4,175 psi
Auxiliary Pump – Maximum Flow (optional)	54 L/min	14 gal/min
Auxiliary Pump – Maximum Pressure (optional)	14 000 kPa	2,030 psi
Auxiliary Pump for Blade – Maximum Flow (optional)	77 L/min	20 gal/min
Auxiliary Pump for Blade – Maximum Pressure (optional)	24,500 kPa	3,553 psi
Boom Cylinder – Bore	140 mm	5.5 in
Boom Cylinder – Stroke	1407 mm	55.4 in
Stick Cylinder – Bore	160 mm	6.3 in
Stick Cylinder – Stroke	1646 mm	64.8 in
Bucket Cylinder – Bore	145 mm	5.7 in
Bucket Cylinder – Stroke	1156 mm	45.5 in

Service Refill Capacities

Fuel Tank Capacity	368 L	97.2 gal
Cooling System	13 L	3.3 gal
Engine Oil	25 L	6.6 gal
Swing Drive	11 L	2.9 gal
Final Drive (each)	7 L	1.8 gal
Hydraulic System (including tank)	350 L	92.5 gal
Hydraulic Tank	154 L	40.7 gal
Diesel Exhaust Fluid (DEF) Tank	26 L	7 gal

Air Conditioning System

The air conditioning system on this machine contains the fluorinated greenhouse gas refrigerant R134a (Global Warming Potential = 1430). The system contains 0.9 kg of refrigerant, which has a CO₂ equivalent of 1.287 metric tonnes.

Standards

Brakes	ISO 10265:2008
Cab/Rollover Protective Structure (ROPS)	ISO 12117-2:2008
Cab/Operator Protective Guards (OPG) (optional)	ISO 10262:1998 Level II

Sound Performance

ISO 6395:2008 (external)	104 dB(A)
ISO 6396:2008 (inside cab)	71 dB(A)

- Hearing protection may be needed when operating with an open operator station and cab (when not properly maintained or doors/windows open) for extended periods or in a noisy environment.

335 Hydraulic Excavator Specifications

Operating Weights and Ground Pressures

	600 mm (24") Triple Grouser Shoes		700 mm (28") Triple Grouser Shoes		850 mm (33") Triple Grouser Shoes	
	Weight	Ground Pressure	Weight	Ground Pressure	Weight	Ground Pressure
	kg (lb)	kPa (psi)	kg (lb)	kPa (psi)	kg (lb)	kPa (psi)
Base machine with 7.7 mt (16,980 lb) Counterweight and Long Undercarriage						
Reach Boom + R3.2CB2 (10'6") Stick + 1.54 m ³ (2.01 yd ³) HD Bucket	35 000 (77,200)	65.2 (9.5)	35 400 (77,900)	56.5 (8.2)	36 200 (79,900)	47.6 (6.9)
Base machine with 5.0 mt (11,020 lb) Counterweight and Long Undercarriage						
Reach Boom + R3.2CB2 (10'6") Stick + 1.54 m ³ (2.01 yd ³) HD Bucket + 3440 mm (11'3") Blade	34 900 (77,000)	65.0 (9.4)	35 300 (77,700)	56.3 (8.2)	–	–
Base machine with 5.0 mt (11,020 lb) Counterweight and Long Undercarriage						
Reach Boom + R3.2CB2 (10'6") Stick + 1.54 m ³ (2.01 yd ³) HD Bucket + 3600 mm (11'10") Blade	–	–	–	–	36,300 (80,000)	47.8 (6.9)

All operating weights include a 90% fuel tank with 75 kg (165 lb) operator.

Major Component Weights

	kg	lb
Base Machine (with upper frame, long undercarriage, counterweight and two boom cylinders – does not include boom, stick, bucket, stick cylinder, bucket cylinder, tracks, blade, 90% fuel tank and 75 kg [165 lb] operator).		
With 5.0 mt (11,020 lb) counterweight for use with Blade	23 180	51,110
With 7.7 mt (16,980 lb) counterweight for use without Blade	24 950	55,010
Track Shoes:		
600 mm (24") Width, 11 mm (0.43") Thick Triple Grouser Track Shoes	4090	9,020
700 mm (28") Width, 11 mm (0.43") Thick, Triple Grouser Track Shoes	4440	9,800
850 mm (33") Width, 13 mm (0.51") Thick Triple Grouser Track Shoes with Step Extension	5310	11,720
Two Boom Cylinders	490	1,080
Weight of 90% Fuel Tank and 75 kg (165 lb) Operator	360	790
Counterweights:		
5.0 mt (11,020 lb) Counterweight for use with Blade	5000	11,020
7.7 mt (16,980 lb) Counterweight for use without Blade	7700	16,980
Boom (including lines, pins, stick cylinder):		
Reach Boom 6.15 m (20'2")	2660	5,870
Sticks (including lines, pins, bucket cylinder, bucket linkage):		
Reach Stick R3.2CB2 (10'6")	1680	3,690
Reach Stick R3.75CB2 (12'4")	1730	3,810
Blades:		
3440 mm (11'3") Blade for use with 600 mm (24") Track Shoes and 700 mm (28") Track Shoes	1680	3,710
3600 mm (11'10") Blade for use with 850 mm (33") Track Shoes	1810	3,990
Buckets (without linkage, with tips and side-cutters):		
0.91 m ³ (1.19 yd ³) Heavy Duty (HD)	990	2,190
1.12 m ³ (1.46 yd ³) HD	1090	2,400
1.33 m ³ (1.74 yd ³) HD	1160	2,560
1.54 m ³ (2.01 yd ³) HD	1260	2,780
1.73 m ³ (2.26 yd ³) HD	1290	2,850
Quick Couplers (QC):		
Pin Grabber QC CB with Pins	530	1,180
Pin Grabber QC CB without Pins	430	960

335 Hydraulic Excavator Specifications

Dimensions

All dimensions are approximate and may vary depending on bucket selection.

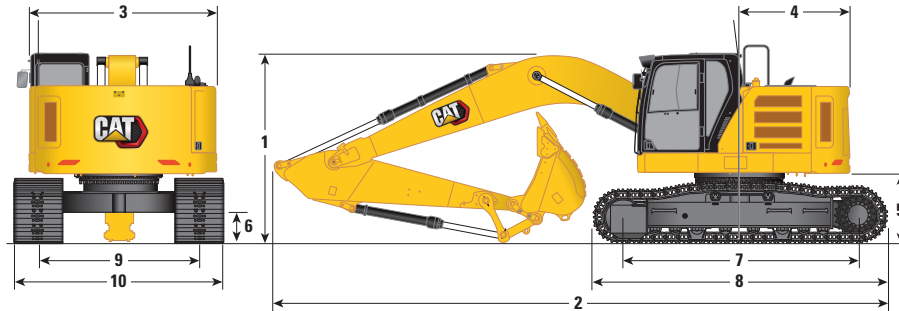

Boom Option	Reach Boom 6.15 m (20'2")			
	Stick Options		Reach Stick	
	R3.2CB2 (10'6")		R3.75CB2 (12'4")	
1 Machine Height:				
Cab Height	3270 mm	10'9"	3270 mm	10'9"
Top of Global Navigation Satellite System (GNSS) Antenna Height (if installed)	2780 mm	9'1"	2780 mm	9'1"
OPG Height	3420 mm	11'2"	3420 mm	11'2"
Handrail Height	3430 mm	11'3"	3430 mm	11'3"
With Boom/Stick/Bucket/QC Installed	3580 mm ⁽¹⁾	11'9" ⁽¹⁾	3690 mm	12'1"
With Boom/Stick/Bucket Installed	3400 mm	11'2"	3690 mm	12'2"
With Boom/Stick Installed	3320 mm	10'11"	3530 mm	11'7"
With Boom Installed	2800 mm	9'2"	2800 mm	9'2"
2 Machine Length:				
With Boom/Stick/Bucket/QC Installed	9850 mm ⁽²⁾	32'4" ⁽²⁾	9870 mm	32'5"
With Boom/Stick/Bucket Installed	9830 mm	32'3"	9870 mm	32'5"
With Boom/Stick Installed	9810 mm	32'2"	9860 mm	32'4"
With Boom Installed	8580 mm	28'2"	8580 mm	28'2"
Track Length	5030 mm	16'6"	5030 mm	16'6"
Track Length (with blade)	5740 mm	18'10"	5740 mm	18'10"
3 Upperframe Width	3250 mm	10'8"	3250 mm	10'8"
4 Tail Swing Radius	1900 mm	6'3"	1900 mm	6'3"
5 Counterweight Clearance	1170 mm	3'10"	1170 mm	3'10"
6 Ground Clearance	480 mm	1'7"	480 mm	1'7"
7 Track Length:				
Length to Center of Rollers	4040 mm	13'3"	4040 mm	13'3"
8 Crawler Overall Length	5030 mm	16'6"	5030 mm	16'6"
9 Track Gauge	2740 mm	9'0"	2740 mm	9'0"
10 Machine Width:				
600 mm (24") Shoes	3340 mm	10'11"	3340 mm	10'11"
700 mm (28") Shoes	3440 mm	11'3"	3440 mm	11'3"
850 mm (33") Shoes	3590 mm	11'9"	3590 mm	11'9"
Machine Width with Blade:				
With 3440 mm (11'3") Blade	3440 mm	11'3"	3440 mm	11'3"
With 3600 mm (11'10") Blade	3600 mm	11'10"	3600 mm	11'10"
Bucket Type	HD		HD	
Bucket Capacity	1.54 m ³ ⁽³⁾	2.01 yd ³ ⁽³⁾	1.54 m ³ ⁽³⁾	2.01 yd ³ ⁽³⁾
Bucket Tip Radius	1662 mm	5'5"	1662 mm	5'5"

⁽¹⁾3520 mm (11'7") for 335 models sold in Europe

⁽²⁾9830 mm (32'3") for 335 models sold in Europe

⁽³⁾1.76 m³ (2.30 yd³) for 335 models sold in Europe

335 Hydraulic Excavator Specifications

Working Ranges and Forces

All dimensions are approximate and may vary depending on bucket selection.

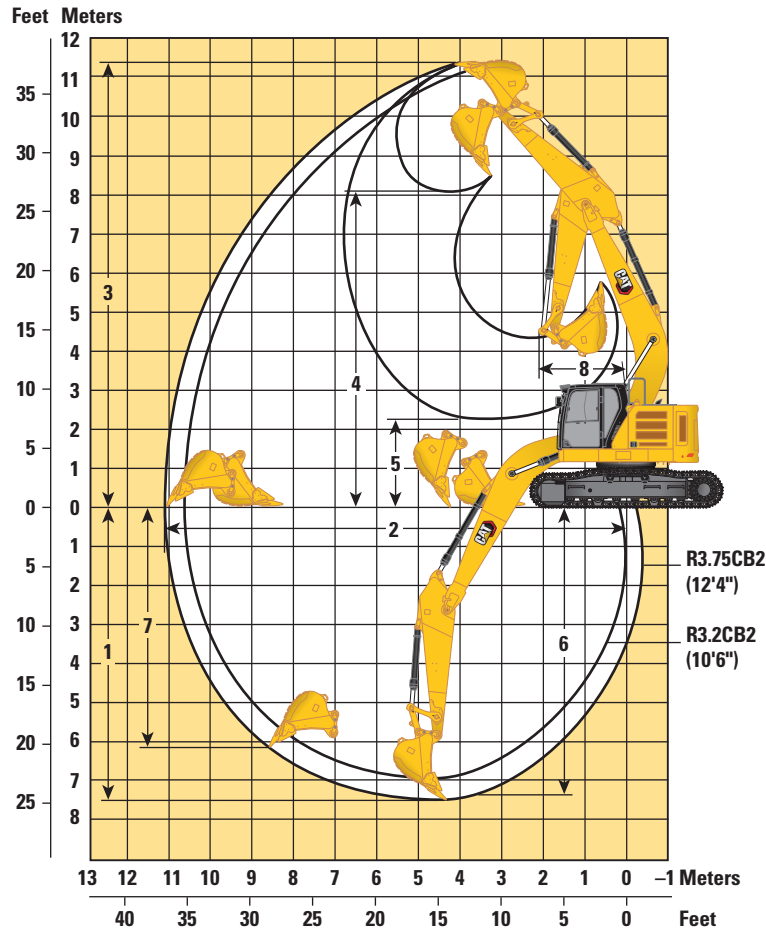

Boom Option	Reach Boom 6.15 m (20'2")			
	Stick Options		Reach Stick	
	R3.2CB2 (10'6")		R3.75CB2 (12'4")	
1 Maximum Digging Depth	6990 mm	22'11"	7540 mm	24'9"
2 Maximum Reach at Ground Line	10 640 mm	34'11"	11 150 mm	36'7"
3 Maximum Cutting Height	11 150 mm	36'7"	11 400 mm	37'5"
4 Maximum Loading Height	7960 mm	26'1"	8220 mm	27'0"
5 Minimum Loading Height	2910 mm	9'7"	2370 mm	7'9"
6 Maximum Depth Cut for 2440 mm (8'0") Level Bottom	6840 mm	22'5"	7400 mm	24'3"
7 Maximum Vertical Wall Digging Depth	5790 mm	19'0"	6230 mm	20'5"
8 Minimum Working Equipment Radius	3410 mm	11'2"	3450 mm	11'4"
Bucket Digging Force	207 kN	46,482 lbf	207 kN	46,482 lbf
Stick Digging Force	144 kN	32,319 lbf	130 kN	29,207 lbf
Bucket Digging Force (ISO) – Auto Dig Boost	224 kN	50,466 lbf	224 kN	50,466 lbf
Stick Digging Force (ISO) – Auto Dig Boost	156 kN	35,089 lbf	141 kN	37,711 lbf
Bucket Type	HD		HD	
Bucket Capacity	1.54 m ³	2.01 yd ³	1.54 m ³	2.01 yd ³
Bucket Tip Radius	1662 mm	5'5"	1662 mm	5'5"

335 Hydraulic Excavator Specifications

Blade Dimensions

All dimensions are approximate.

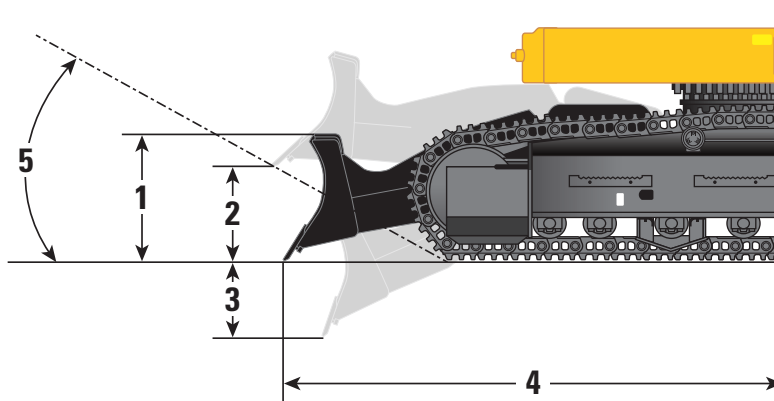

Blade Options	3440 mm (11'3")		3600 mm (11'10")	
Track Shoe Width	600 mm (24")/700 mm (28")		850 mm (33")	
1 Blade Moldboard Height	840 mm	2'9"	840 mm	2'9"
2 Blade Maximum Cutting Edge Rise	470 mm	1'6"	470 mm	1'6"
3 Blade Minimum Cutting Edge Depth	240 mm	10"	240 mm	10"
4 Blade Edge from Machine Center	3220 mm	10'7"	3220 mm	10'7"
5 Ramp Angle	20.8°		20.8°	
Blade Down Force – Ground Level	175 kN	39.3 klpf	175 kN	39.3 klpf
Blade Down Force – Maximum	179.8 kN	40.4 klpf	179.8 kN	40.4 klpf

335 Hydraulic Excavator Specifications

Reach Boom Lift Capacities – Counterweight: 7.7 mt (16,980 lb) – without Bucket, Heavy Lift: On

Long Undercarriage

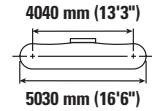
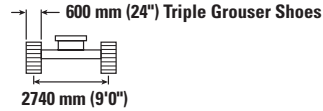
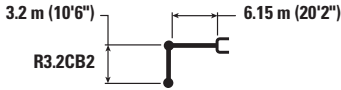

Reach	Unit	1.5 m/5.0 ft		3.0 m/10.0 ft		4.5 m/15.0 ft		6.0 m/20.0 ft		7.5 m/25.0 ft		9.0 m/30.0 ft		m		ft/in
		kg	lb	kg	lb	kg	lb	kg	lb	kg	lb	kg	lb	kg	lb	
9.0 m	kg							*7450	*7450					*7250	*7250	6.04
30'0"	lb													*16,150	*16,150	19'3"
7.5 m	kg							*8000	*8000					*6500	6150	7.44
25.0 ft	lb							*17,600	*17,600					*14,450	13,800	24'1"
6.0 m	kg							*8500	*8500	*7950	6050			*6250	5050	8.33
20.0 ft	lb							*18,450	*18,450	*17,400	12,950			*13,800	11,200	27'2"
4.5 m	kg			*16 950	*16 950	*11 750	*11 750	*9550	8300	*8400	5900			*6250	4450	8.88
15.0 ft	lb			*35,950	*35,950	*25,250	*25,250	*20,700	17,900	*18,250	12,650			*13,800	9,850	29'0"
3.0 m	kg					*14 550	12 100	*10 850	7900	8850	5650	6700	4300	*6450	4150	9.16
10.0 ft	lb					*31,300	26,100	*23,500	17,000	19,050	12,200	*14,300	9,200	*14,200	9,150	30'0"
1.5 m	kg					*16 500	11 350	*11 950	7500	8650	5450	6600	4200	6400	4050	9.17
5.0 ft	lb					*35,700	24,450	*25,850	16,150	18,600	11,750	14,150	9,000	14,100	8,950	30'1"
0 m	kg			*7250	*7250	*17 050	11 000	11 900	7250	8500	5300			6600	4150	8.94
0 ft	lb			*16,550	*16,550	*36,900	23,650	25,500	15,600	18,250	11,450			14,500	9,150	29'3"
-1.5 m	kg	*8950	*8950	*13 550	*13 550	*16 350	10 950	11 750	7150	8400	5250			7150	4500	8.43
-5.0 ft	lb	*20,000	*20,000	*30,750	*30,750	*35,450	23,450	25,250	15,350	18,100	11,300			15,750	9,950	27'7"
-3.0 m	kg			*19 600	*19 600	*14 600	11 050	*11 100	7200	*8200	5300			*8000	5250	7.59
-10.0 ft	lb			*42,450	*42,450	*31,550	23,700	*23,900	15,450					*17,650	11,650	24'9"
-4.5 m	kg			*14 650	*14 650	*11 300	*11 300	*8200	7400					*7500	7000	6.28
-15.0 ft	lb			*31,350	*31,350	*24,050	*24,050	*16,950	16,050					*16,350	15,700	20'3"



ISO 10567:2007



* Indicates that the load is limited by hydraulic lifting capacity rather than tipping load. The above loads are in compliance with hydraulic excavator lift capacity standard ISO 10567:2007. They do not exceed 87% of hydraulic lifting capacity or 75% of tipping load. Weight of all lifting accessories must be deducted from the above lifting capacities. Lifting capacities are based on the machine standing on a firm, uniform supporting surface. The use of a work tool attachment point to handle/lift objects, could affect the machine lift performance.

Lift capacity stays with ±5% for all available track shoes.

Always refer to the appropriate Operation and Maintenance Manual for specific product information.

335 Hydraulic Excavator Specifications

Reach Boom Lift Capacities – Counterweight: 7.7 mt (16,980 lb) – without Bucket, Heavy Lift: On

Long Undercarriage

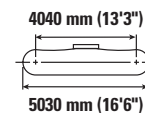
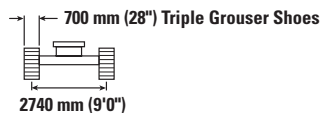
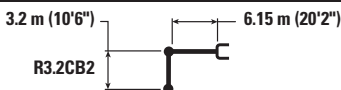

Reach	Unit	1.5 m/5.0 ft		3.0 m/10.0 ft		4.5 m/15.0 ft		6.0 m/20.0 ft		7.5 m/25.0 ft		9.0 m/30.0 ft		m		ft/in
		kg	lb	kg	lb	kg	lb	kg	lb	kg	lb	kg	lb	kg	lb	
9.0 m	kg							*7450	*7450					*7250	*7250	6.04
30'0"	lb													*16,150	*16,150	19'3"
7.5 m	kg							*8000	*8000					*6500	6200	7.44
25.0 ft	lb							*17,600	*17,600					*14,450	13,950	24'1"
6.0 m	kg							*8500	*8500	*7950	6100			*6250	5100	8.33
20.0 ft	lb							*18,450	*18,450	*17,400	13,100			*13,800	11,300	27'2"
4.5 m	kg			*16 950	*16 950	*11 750	*11 750	*9550	8400	*8400	5950			*6250	4500	8.88
15.0 ft	lb			*35,950	*35,950	*25,250	*25,250	*20,700	18,100	*18,250	12,750			*13,800	9,950	29'0"
3.0 m	kg					*14 550	12 250	*10 850	7950	8950	5750	6750	4350	*6450	4200	9.16
10.0 ft	lb					*31,300	26,350	*23,500	17,150	19,300	12,300	*14,300	9,300	*14,200	9,300	30'0"
1.5 m	kg					*16 500	11 500	*11 950	7600	8750	5500	6650	4250	6500	4100	9.17
5.0 ft	lb					*35,700	24,700	*25,850	16,350	18,800	11,900	14,300	9,100	14,250	9,050	30'1"
0 m	kg			*7250	*7250	*17 050	11 150	12 000	7350	8600	5400			6650	4200	8.94
0 ft	lb			*16,550	*16,550	*36,900	23,950	25,800	15,800	18,450	11,550			14,700	9,300	29'3"
-1.5 m	kg	*8950	*8950	*13 550	*13 550	*16 350	11 050	11 900	7250	8500	5300			7250	4550	8.43
-5.0 ft	lb	*20,000	*20,000	*30,750	*30,750	*35,450	23,750	25,550	15,550	18,300	11,450			15,950	10,050	27'7"
-3.0 m	kg			*19 600	*19 600	*14 600	11 150	*11 100	7250	*8200	5400			*8000	5300	7.59
-10.0 ft	lb			*42,450	*42,450	*31,550	23,950	*23,900	15,650					*17,650	11,750	24'9"
-4.5 m	kg			*14 650	*14 650	*11 300	*11 300	*8200	7500					*7500	7100	6.28
-15.0 ft	lb			*31,350	*31,350	*24,050	*24,050	*16,950	16,200					*16,350	15,900	20'3"



ISO 10567:2007



* Indicates that the load is limited by hydraulic lifting capacity rather than tipping load. The above loads are in compliance with hydraulic excavator lift capacity standard ISO 10567:2007. They do not exceed 87% of hydraulic lifting capacity or 75% of tipping load. Weight of all lifting accessories must be deducted from the above lifting capacities. Lifting capacities are based on the machine standing on a firm, uniform supporting surface. The use of a work tool attachment point to handle/lift objects, could affect the machine lift performance.

Lift capacity stays with ±5% for all available track shoes.

Always refer to the appropriate Operation and Maintenance Manual for specific product information.

335 Hydraulic Excavator Specifications

Reach Boom Lift Capacities – Counterweight: 7.7 mt (16,980 lb) – without Bucket, Heavy Lift: On

Long Undercarriage

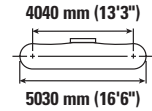
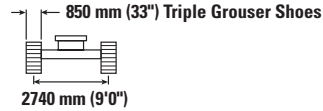
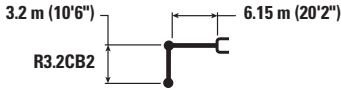

Reach	Unit	1.5 m/5.0 ft		3.0 m/10.0 ft		4.5 m/15.0 ft		6.0 m/20.0 ft		7.5 m/25.0 ft		9.0 m/30.0 ft		m ft/in		
		kg lb	kg lb	kg lb	kg lb	kg lb	kg lb	kg lb	kg lb	kg lb	kg lb	kg lb	kg lb	kg lb	kg lb	kg lb
9.0 30'0"	kg lb							*7450	*7450					*7250 *16,150	*7250 *16,150	6.04 19'3"
7.5 m 25.0 ft	kg lb							*8000 *17,600	*8000 *17,600					*6500 *14,450	6350 14,300	7.44 24'1"
6.0 m 20.0 ft	kg lb							*8500 *18,450	*8500 *18,450	*7950 *17,400	6250 13,450			*6250 *13,800	5250 11,650	8.33 27'2"
4.5 m 15.0 ft	kg lb			*16 950 *35,950	*16 950 *35,950	*11 750 *25,250	*11 750 *25,250	*9550 *20,700	8600 18,550	*8400 *18,250	6100 13,100			*6250 *13,800	4650 10,250	8.88 29'0"
3.0 m 10.0 ft	kg lb					*14 550 *31,300	12 550 27,050	*10 850 *23,500	8200 17,600	*9000 *19,550	5900 12,650	6950 *14,300	4450 9,550	*6450 *14,200	4350 9,550	9.16 30'0"
1.5 m 5.0 ft	kg lb					*16 500 *35,700	11 800 25,400	*11 950 *25,850	7800 16,800	9000 19,300	5700 12,250	6850 14,750	4350 9,400	6650 14,650	4250 9,350	9.17 30'1"
0 m 0 ft	kg lb			*7250 *16,550	*7250 *16,550	*17 050 *36,900	11 450 24,600	12 350 26,500	7550 16,250	8800 18,950	5550 11,900			6850 15,100	4350 9,550	8.94 29'3"
-1.5 m -5.0 ft	kg lb	*8950 *20,000	*8950 *20,000	*13 550 *30,750	*13 550 *30,750	*16 350 *35,450	11 350 24,450	12200 26,250	7450 16,000	8750 18,850	5500 11,800			7450 16,400	4700 10,350	8.43 27'7"
-3.0 m -10.0 ft	kg lb			*19 600 *42,450	*19 600 *42,450	*14 600 *31,550	11 450 24,650	*11 100 *23,900	7500 16,100	*8200 18,000	5550			*8000 *17,650	5450 12,100	7.59 24'9"
-4.5 m -15.0 ft	kg lb			*14 650 *31,350	*14 650 *31,350	*11 300 *24,050	*11 300 *24,050	*8200 *16,950	7700 16,700					*7500 *16,350	7300 16,350	6.28 20'3"



ISO 10567:2007



* Indicates that the load is limited by hydraulic lifting capacity rather than tipping load. The above loads are in compliance with hydraulic excavator lift capacity standard ISO 10567:2007. They do not exceed 87% of hydraulic lifting capacity or 75% of tipping load. Weight of all lifting accessories must be deducted from the above lifting capacities. Lifting capacities are based on the machine standing on a firm, uniform supporting surface. The use of a work tool attachment point to handle/lift objects, could affect the machine lift performance.

Lift capacity stays with ±5% for all available track shoes.

Always refer to the appropriate Operation and Maintenance Manual for specific product information.

335 Hydraulic Excavator Specifications

Reach Boom Lift Capacities – Counterweight: 7.7 mt (16,980 lb) – without Bucket, Heavy Lift: On

Long Undercarriage

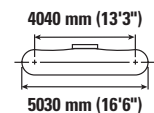
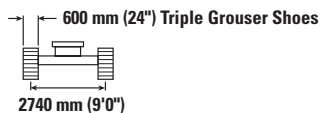
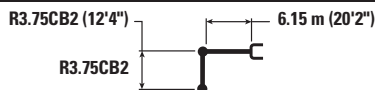

Reach	Unit	1.5 m/5.0 ft		3.0 m/10.0 ft		4.5 m/15.0 ft		6.0 m/20.0 ft		7.5 m/25.0 ft		9.0 m/30.0 ft		m		ft/in	
		kg	lb	kg	lb	kg	lb	kg	lb	kg	lb	kg	lb	kg	lb		
9.0 m 30'0"	kg																
	lb																
7.5 m 25.0 ft	kg																
	lb																
6.0 m 20.0 ft	kg																
	lb																
4.5 m 15.0 ft	kg																
	lb																
3.0 m 10.0 ft	kg																
	lb																
1.5 m 5.0 ft	kg																
	lb																
0 m 0 ft	kg																
	lb																
-1.5 m -5.0 ft	kg																
	lb																
-3.0 m -10.0 ft	kg																
	lb																
-4.5 m -15.0 ft	kg																
	lb																



ISO 10567:2007



* Indicates that the load is limited by hydraulic lifting capacity rather than tipping load. The above loads are in compliance with hydraulic excavator lift capacity standard ISO 10567:2007. They do not exceed 87% of hydraulic lifting capacity or 75% of tipping load. Weight of all lifting accessories must be deducted from the above lifting capacities. Lifting capacities are based on the machine standing on a firm, uniform supporting surface. The use of a work tool attachment point to handle/lift objects, could affect the machine lift performance.

Lift capacity stays with ±5% for all available track shoes.

Always refer to the appropriate Operation and Maintenance Manual for specific product information.

335 Hydraulic Excavator Specifications

Reach Boom Lift Capacities – Counterweight: 7.7 mt (16,980 lb) – without Bucket, Heavy Lift: On

Long Undercarriage

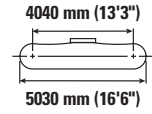
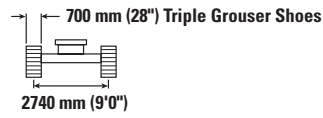
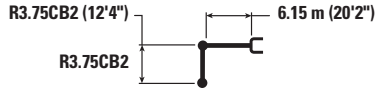

Reach	Unit	1.5 m/5.0 ft		3.0 m/10.0 ft		4.5 m/15.0 ft		6.0 m/20.0 ft		7.5 m/25.0 ft		9.0 m/30.0 ft		m		ft/in	
		kg	lb	kg	lb	kg	lb	kg	lb	kg	lb	kg	lb	kg	lb		
9.0 m 30'0"	kg																
	lb																
7.5 m 25.0 ft	kg																
	lb																
6.0 m 20.0 ft	kg																
	lb																
4.5 m 15.0 ft	kg																
	lb																
3.0 m 10.0 ft	kg																
	lb																
1.5 m 5.0 ft	kg																
	lb																
0 m 0 ft	kg																
	lb																
-1.5 m -5.0 ft	kg																
	lb																
-3.0 m -10.0 ft	kg																
	lb																
-4.5 m -15.0 ft	kg																
	lb																



ISO 10567:2007



* Indicates that the load is limited by hydraulic lifting capacity rather than tipping load. The above loads are in compliance with hydraulic excavator lift capacity standard ISO 10567:2007. They do not exceed 87% of hydraulic lifting capacity or 75% of tipping load. Weight of all lifting accessories must be deducted from the above lifting capacities. Lifting capacities are based on the machine standing on a firm, uniform supporting surface. The use of a work tool attachment point to handle/lift objects, could affect the machine lift performance.

Lift capacity stays with ±5% for all available track shoes.

Always refer to the appropriate Operation and Maintenance Manual for specific product information.

335 Hydraulic Excavator Specifications

Reach Boom Lift Capacities – Counterweight: 7.7 mt (16,980 lb) – without Bucket, Heavy Lift: On

Long Undercarriage

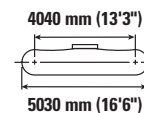
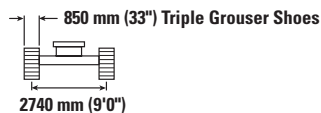
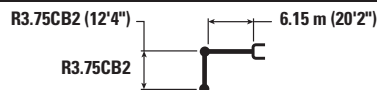

Reach	Unit	1.5 m/5.0 ft		3.0 m/10.0 ft		4.5 m/15.0 ft		6.0 m/20.0 ft		7.5 m/25.0 ft		9.0 m/30.0 ft		m		ft/in
		kg	lb	kg	lb	kg	lb	kg	lb	kg	lb	kg	lb	kg	lb	
9.0 m 30'0"	kg													*6050	*6050	6.78
	lb													*13,500	*13,500	21'8"
7.5 m 25.0 ft	kg									*7200	6350			*5550	*5550	8.04
	lb									*15,100	13,600			*12,250	*12,250	26'1"
6.0 m 20.0 ft	kg									*7700	*7700			*5350	4700	8.88
	lb									*16,750	*16,750			*11,800	10,450	28'11"
4.5 m 15.0 ft	kg					*10 500	*10 500	*8800	8700	*7850	6100	7050	4550	*5400	4200	9.39
	lb					*22,550	*22,550	*19,050	18,700	*17,050	13,150	*14,600	9,750	*11,800	9,300	30'8"
3.0 m 10.0 ft	kg					*13 400	12 750	*10 200	8250	*8550	5900	6950	4450	*5550	3950	9.65
	lb					*28,800	27,500	*22,000	17,750	*18,550	12,650	14,900	9,500	*12,200	8,700	31'7"
1.5 m 5.0 ft	kg					*15 750	11 900	*11 450	7800	8950	5650	6800	4300	*5900	3850	9.67
	lb					*34,000	25,550	*24,750	16,800	19,250	12,150	14,600	9,250	*12,950	8,500	31'8"
0 m 0 ft	kg			*8300	*8300	*16 800	11 400	*12 200	7500	8750	5450	6700	4200	6250	3950	9.45
	lb			*18,950	*18,950	*36,350	24,450	*26,400	16,100	18,800	11,750	14,400	9,050	13,750	8,650	30'11"
-1.5 m -5.0 ft	kg	*8350	*8350	*12 900	*12 900	*16 600	11 200	12 100	7300	8650	5350			6700	4200	8.97
	lb	*18,600	*18,600	*29,200	*29,200	*35,950	24,050	26,000	15,750	18,600	11,550			14,800	9,300	29'4"
-3.0 m -10.0 ft	kg	*13 400	*13 400	*19 150	*19 150	*15 250	11 250	*11 500	7300	8650	5350			*7600	4800	8.18
	lb	*30,050	*30,050	*43,450	*43,450	*33,000	24,150	*24,800	15,750	18,600	11,550			*16,800	10,650	26'8"
-4.5 m -15.0 ft	kg			*17 050	*17 050	*12 650	11 450	*9450	7450					*7400	6100	6.99
	lb			*36,600	*36,600	*27,050	24,650	*20,050	16,100					*16,200	13,600	22'8"



ISO 10567:2007



* Indicates that the load is limited by hydraulic lifting capacity rather than tipping load. The above loads are in compliance with hydraulic excavator lift capacity standard ISO 10567:2007. They do not exceed 87% of hydraulic lifting capacity or 75% of tipping load. Weight of all lifting accessories must be deducted from the above lifting capacities. Lifting capacities are based on the machine standing on a firm, uniform supporting surface. The use of a work tool attachment point to handle/lift objects, could affect the machine lift performance.

Lift capacity stays with ±5% for all available track shoes.

Always refer to the appropriate Operation and Maintenance Manual for specific product information.

335 Hydraulic Excavator Specifications

Reach Boom Lift Capacities – Counterweight: 5.0 mt (11,023 lb) – without Bucket, Heavy Lift: On, Blade Up

Long Undercarriage, 3440 mm (11'3") Blade

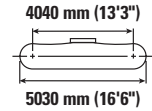
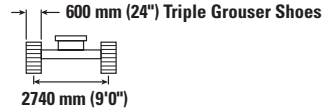
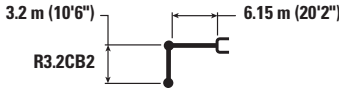

Reach	Unit	1.5 m/5.0 ft		3.0 m/10.0 ft		4.5 m/15.0 ft		6.0 m/20.0 ft		7.5 m/25.0 ft		9.0 m/30.0 ft		m		ft/in
		kg	lb	kg	lb	kg	lb	kg	lb	kg	lb	kg	lb	kg	lb	
9.0 m 30'0"	kg							*7450	*7450					*7250	*7250	6.04
	lb													*16,150	*16,150	19'3"
7.5 m 25.0 ft	kg							*8000	*8000					*6500	5600	7.44
	lb							*17,600	17,450					*14,450	12,550	24'1"
6.0 m 20.0 ft	kg							*8500	7950	7900	5500			*6250	4550	8.33
	lb							*18,450	17,100	16,900	11,800			*13,800	10,150	27'2"
4.5 m 15.0 ft	kg			*16 950	*16 950	*11 750	*11 750	*9550	7600	7700	5350			5800	4000	8.88
	lb			*35,950	*35,950	*25,250	*25,250	*20,700	16,350	16,550	11,450			12,850	8,900	29'0"
3.0 m 10.0 ft	kg					*14 550	11 050	10 700	7150	7500	5150	5600	3850	5450	3750	9.16
	lb					*31,300	23,750	22,950	15,450	16,050	11,000	12,000	8,250	12,000	8,250	30'0"
1.5 m 5.0 ft	kg					*16 500	10 300	10 250	6800	7250	4900	5500	3750	5350	3650	9.17
	lb					*35,600	22,150	22,000	14,600	15,600	10,600	11,800	8,050	11,750	8,000	30'1"
0 m 0 ft	kg			*7250	*7250	16 200	9950	9950	6550	7100	4750			5500	3750	8.94
	lb			*16,550	*16,550	34,650	21,350	21,400	14,050	15,250	10,250			12,100	8,200	29'3"
-1.5 m -5.0 ft	kg	*8950	*8950	*13 550	*13 550	16 100	9850	9850	6450	7000	4700			5950	4050	8.43
	lb	*20,000	*20,000	*30,750	*30,750	34,450	21,150	21,150	13,800	15,100	10,150			13,150	8,900	27'7"
-3.0 m -10.0 ft	kg			*19 600	*19 600	*14 600	9950	9900	6450	7100	4800			7000	4700	7.59
	lb			*42,450	*42,450	*31,550	21,400	21,250	13,900					15,500	10,450	24'9"
-4.5 m -15.0 ft	kg			*14 650	*14 650	*11 300	10 250	*8200	6700					*7500	6300	6.28
	lb			*31,350	*31,350	*24,050	22,050	*16,950	14,500					*16,350	14,200	20'3"



ISO 10567:2007



* Indicates that the load is limited by hydraulic lifting capacity rather than tipping load. The above loads are in compliance with hydraulic excavator lift capacity standard ISO 10567:2007. They do not exceed 87% of hydraulic lifting capacity or 75% of tipping load. Weight of all lifting accessories must be deducted from the above lifting capacities. Lifting capacities are based on the machine standing on a firm, uniform supporting surface. The use of a work tool attachment point to handle/lift objects, could affect the machine lift performance.

Lift capacity stays with ±5% for all available track shoes.

Always refer to the appropriate Operation and Maintenance Manual for specific product information.

335 Hydraulic Excavator Specifications

Reach Boom Lift Capacities – Counterweight: 5.0 mt (11,023 lb) – without Bucket, Heavy Lift: On, Blade Down

Long Undercarriage, 3440 mm (11'3") Blade

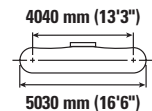
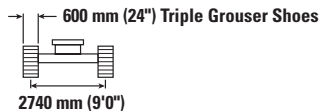
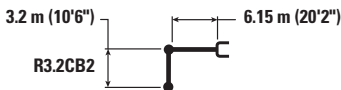

Reach	Unit	1.5 m/5.0 ft		3.0 m/10.0 ft		4.5 m/15.0 ft		6.0 m/20.0 ft		7.5 m/25.0 ft		9.0 m/30.0 ft		m		ft/in
		kg	lb	kg	lb	kg	lb	kg	lb	kg	lb	kg	lb	kg	lb	
9.0 30'0"	kg							*7450	*7450					*7250	*7250	6.04
	lb													*16,150	*16,150	19'3"
7.5 m 25.0 ft	kg							*8000	*8000					*6500	6150	7.44
	lb							*17,600	*17,600					*14,450	13,750	24'1"
6.0 m 20.0 ft	kg							*8500	*8500	*7950	6000			*6250	5000	8.33
	lb							*18,450	*18,450	*17,400	12,900			*13,800	11,150	27'2"
4.5 m 15.0 ft	kg			*16 950	*16 950	*11 750	*11 750	*9550	8350	*8400	5850			*6250	4450	8.88
	lb			*35,950	*35,950	*25,250	*25,250	*20,700	17,950	*18,250	12,600			*13,800	9,800	29'0"
3.0 m 10.0 ft	kg					*14 550	12 300	*10 850	7900	*9000	5650	*7850	4250	*6450	4150	9.16
	lb					*31,300	26,450	*23,500	17,000	*19,550	12,150	*14,300	9,100	*14,200	9,100	30'0"
1.5 m 5.0 ft	kg					*16 500	11 500	*11 950	7500	*9600	5450	*8100	4150	*6900	4050	9.17
	lb					*35,700	24,750	*25,850	16,150	*20,750	11,700	*15,900	8,900	*15,150	8,900	30'1"
0 m 0 ft	kg			*7250	*7250	*17 050	11 150	*12 500	7250	*9850	5300			*7650	4150	8.94
	lb			*16,550	*16,550	*36,900	23,950	*27,050	15,600	*21,300	11,350			*16,800	9,100	29'3"
-1.5 m -5.0 ft	kg	*8950	*8950	*13 550	*13 550	*16 350	11 050	*12 250	7150	*9550	5250			*8100	4500	8.43
	lb	*20,000	*20,000	*30,750	*30,750	*35,450	23,750	*26,550	15,400	*20,600	11,250			*17,800	9,850	27'7"
-3.0 m -10.0 ft	kg			*19 600	*19 600	*14 600	11 150	*11 100	7200	*8200	5300			*8000	5250	7.59
	lb			*42,450	*42,450	*31,550	23,950	*23,900	15,500					*17,650	11,600	24'9"
-4.5 m -15.0 ft	kg			*14 650	*14 650	*11 300	*11 300	*8200	7450					*7500	7000	6.28
	lb			*31,350	*31,350	*24,050	*24,050	*16,950	16,050					*16,350	15,700	20'3"



ISO 10567:2007



* Indicates that the load is limited by hydraulic lifting capacity rather than tipping load. The above loads are in compliance with hydraulic excavator lift capacity standard ISO 10567:2007. They do not exceed 87% of hydraulic lifting capacity or 75% of tipping load. Weight of all lifting accessories must be deducted from the above lifting capacities. Lifting capacities are based on the machine standing on a firm, uniform supporting surface. The use of a work tool attachment point to handle/lift objects, could affect the machine lift performance.

Lift capacity stays with ±5% for all available track shoes.

Always refer to the appropriate Operation and Maintenance Manual for specific product information.

335 Hydraulic Excavator Specifications

Reach Boom Lift Capacities – Counterweight: 5.0 mt (11,023 lb) – without Bucket, Heavy Lift: On, Blade Up

Long Undercarriage, 3440 mm (11'3") Blade

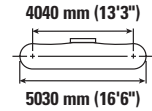
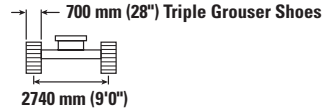
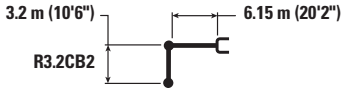

Reach Boom	Unit	1.5 m/5.0 ft		3.0 m/10.0 ft		4.5 m/15.0 ft		6.0 m/20.0 ft		7.5 m/25.0 ft		9.0 m/30.0 ft		m		ft/in
		kg	lb	kg	lb	kg	lb	kg	lb	kg	lb	kg	lb	kg	lb	
9.0 m 30'0"	kg							*7450	*7450					*7250	*7250	6.04
	lb													*16,150	*16,150	19'3"
7.5 m 25.0 ft	kg							*8000	*8000					*6500	5650	7.44
	lb							*17,600	*17,600					*14,450	12,700	24'1"
6.0 m 20.0 ft	kg							*8500	8050	*7950	5550			*6250	4600	8.33
	lb							*18,450	17,250	17,100	11,900			*13,800	10,250	27'2"
4.5 m 15.0 ft	kg			*16 950	*16 950	*11 750	*11 750	*9550	7700	7800	5400			5900	4050	8.88
	lb			*35,950	*35,950	*25,250	*25,250	*20,700	16,550	16,750	11,600			13,000	9,000	29'0"
3.0 m 10.0 ft	kg					*14 550	11 150	10 800	7250	7600	5200	5650	3900	5500	3800	9.16
	lb					*31,300	24,050	23,250	15,600	16,300	11,150	12,150	8,350	12,150	8,350	30'0"
1.5 m 5.0 ft	kg					*16 500	10 400	10 400	6850	7350	5000	5550	3800	5400	3700	9.17
	lb					*35,700	22,400	22,300	14,800	15,800	10,700	11,950	8,150	11,900	8,150	30'1"
0 m 0 ft	kg			*7250	*7250	16 400	10 050	10 100	6600	7200	4850			5550	3800	8.94
	lb			*16,550	*16,550	35,100	21,600	21,700	14,250	15,450	10,400			12,250	8,300	29'3"
-1.5 m -5.0 ft	kg	*8950	*8950	*13 550	*13 550	16 300	10 000	10 000	6500	7100	4800			6050	4100	8.43
	lb	*20,000	*20,000	*30,750	*30,750	34,900	21,450	21,450	14,000	15,300	10,300			13,300	9,000	27'7"
-3.0 m -10.0 ft	kg			*19 600	*19 600	*14 600	10 100	10 000	6550	7200	4850			7100	4800	7.59
	lb			*42,450	*42,450	*31,550	21,650	21,550	14,100					15,700	10,600	24'9"
-4.5 m -15.0 ft	kg			*14 650	*14 650	*11 300	10 350	*8200	6800					*7500	6400	6.28
	lb			*31,350	*31,350	*24,050	22,300	*16,950	14,650					*16,350	14,350	20'3"



ISO 10567:2007



* Indicates that the load is limited by hydraulic lifting capacity rather than tipping load. The above loads are in compliance with hydraulic excavator lift capacity standard ISO 10567:2007. They do not exceed 87% of hydraulic lifting capacity or 75% of tipping load. Weight of all lifting accessories must be deducted from the above lifting capacities. Lifting capacities are based on the machine standing on a firm, uniform supporting surface. The use of a work tool attachment point to handle/lift objects, could affect the machine lift performance.

Lift capacity stays with ±5% for all available track shoes.

Always refer to the appropriate Operation and Maintenance Manual for specific product information.

335 Hydraulic Excavator Specifications

Reach Boom Lift Capacities – Counterweight: 5.0 mt (11,023 lb) – without Bucket, Heavy Lift: On, Blade Down

Long Undercarriage, 3440 mm (11'3") Blade

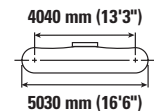
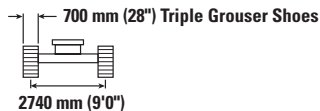
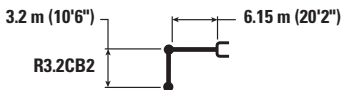

Reach	Unit	1.5 m/5.0 ft		3.0 m/10.0 ft		4.5 m/15.0 ft		6.0 m/20.0 ft		7.5 m/25.0 ft		9.0 m/30.0 ft		m ft/in		
		kg lb	kg lb	kg lb	kg lb	kg lb	kg lb	kg lb	kg lb	kg lb	kg lb	kg lb	kg lb	kg lb	kg lb	kg lb
9.0 30'0"	kg lb							*7450	*7450					*7250 *16,150	*7250 *16,150	6.04 19'3"
7.5 m 25.0 ft	kg lb							*8000 *17,600	*8000 *17,600					*6500 *14,450	6200 13,900	7.44 24'1"
6.0 m 20.0 ft	kg lb							*8500 *18,450	*8500 *18,450	*7950 17,400	6100 13,050			*6250 *13,800	5050 11,250	8.33 27'2"
4.5 m 15.0 ft	kg lb			*16 950 *35,950	*16 950 *35,950	*11 750 *25,250	*11 750 *25,250	*9550 *20,700	8450 18,150	*8400 *18,250	5950 12,750			*6250 *13,800	4500 9,900	8.88 29'0"
3.0 m 10.0 ft	kg lb					*14 550 *31,300	12 400 26,750	*10 850 *23,500	8000 17,200	*9000 *19,550	5700 12,300	*7850 *14,300	4300 9,200	*6450 *14,200	4200 9,200	9.16 30'0"
1.5 m 5.0 ft	kg lb					*16 500 *35,700	11 650 25,050	*11 950 *25,850	7600 16,350	*9600 *20,750	5500 11,850	*8100 *15,900	4200 9,050	*6900 *15,150	4100 9,000	9.17 30'1"
0 m 0 ft	kg lb			*7250 *16,550	*7250 *16,550	*17 050 *36,900	11 300 24,250	*12 500 *27,050	7350 15,800	*9850 *21,300	5350 11,500			*7650 *16,800	4200 9,200	8.94 29'3"
-1.5 m -5.0 ft	kg lb	*8950 *20,000	*8950 *20,000	*13 550 *30,750	*13 550 *30,750	*16 350 *35,450	11 200 24,050	*12 250 *26,550	7250 15,600	*9550 *20,600	5300 11,400			*8100 *17,800	4550 10,000	8.43 27'7"
-3.0 m -10.0 ft	kg lb			*19 600 *42,450	*19 600 *42,450	*14 600 *31,550	11 300 24,300	*11 100 *23,900	7300 15,700	*8200	5350			*8000 *17,650	5300 11,750	7.59 24'9"
-4.5 m -15.0 ft	kg lb			*14 650 *31,350	*14 650 *31,350	*11 300 *24,050	*11 300 *24,050	*8200 *16,950	7550 16,250					*7500 *16,350	7100 15,900	6.28 20'3"



ISO 10567:2007



* Indicates that the load is limited by hydraulic lifting capacity rather than tipping load. The above loads are in compliance with hydraulic excavator lift capacity standard ISO 10567:2007. They do not exceed 87% of hydraulic lifting capacity or 75% of tipping load. Weight of all lifting accessories must be deducted from the above lifting capacities. Lifting capacities are based on the machine standing on a firm, uniform supporting surface. The use of a work tool attachment point to handle/lift objects, could affect the machine lift performance.

Lift capacity stays with ±5% for all available track shoes.

Always refer to the appropriate Operation and Maintenance Manual for specific product information.

335 Hydraulic Excavator Specifications

Reach Boom Lift Capacities – Counterweight: 5.0 mt (11,023 lb) – without Bucket, Heavy Lift: On, Blade Up

Long Undercarriage, 3600 mm (11'10") Blade

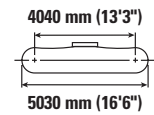
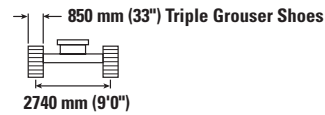
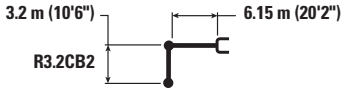

Reach Boom	Unit	1.5 m/5.0 ft		3.0 m/10.0 ft		4.5 m/15.0 ft		6.0 m/20.0 ft		7.5 m/25.0 ft		9.0 m/30.0 ft		m		ft/in
		kg	lb	kg	lb	kg	lb	kg	lb	kg	lb	kg	lb	kg	lb	
9.0 m 30'0"	kg							*7450	*7450					*7250	*7250	6.04
	lb													*16,150	*16,150	19'3"
7.5 m 25.0 ft	kg							*8000	*8000					*6500	5850	7.44
	lb							*17,600	*17,600					*14,450	13,100	24'1"
6.0 m 20.0 ft	kg							*8500	8300	*7950	5750			*6250	4800	8.33
	lb							*18,450	17,800	*17,400	12,300			*13,800	10,600	27'2"
4.5 m 15.0 ft	kg			*16 950	*16 950	*11 750	*11 750	*9550	7950	8050	5600			6050	4200	8.88
	lb			*35,950	*35,950	*25,250	*25,250	*20,700	17,050	17,250	12,000			13,400	9,300	29'0"
3.0 m 10.0 ft	kg					*14 550	11 500	*10 850	7500	7800	5350	5850	4050	5700	3950	9.16
	lb					*31,300	24,850	*23,500	16,150	16,750	11,550	12,550	8,650	12,550	8,650	30'0"
1.5 m 5.0 ft	kg					*16 500	10 750	10 700	7100	7600	5150	5750	3950	5600	3850	9.17
	lb					*35,700	23,200	23,000	15,300	16,300	11,100	12,350	8,500	12,300	8,450	30'1"
0 m 0 ft	kg			*7250	*7250	16 900	10 400	10 400	6850	7400	5000			5750	3950	8.94
	lb			*16,550	*16,550	36,200	22,400	22,350	14,750	15,950	10,800			12,650	8,650	29'3"
-1.5 m -5.0 ft	kg	*8950	*8950	*13 550	*13 550	*16 350	10 350	10 300	6750	7350	4950			6250	4250	8.43
	lb	*20,000	*20,000	*30,750	*30,750	*35,450	22,200	22,100	14,550	15,800	10,650			13,750	9,350	27'7"
-3.0 m -10.0 ft	kg			*19 600	*19 600	*14 600	10 450	10 350	6800	7450	5050			7300	4950	7.59
	lb			*42,450	*42,450	*31,550	22,450	22,200	14,650	16,500				16,200	11,000	24'9"
-4.5 m -15.0 ft	kg			*14 650	*14 650	*11 300	10 750	*8200	7050					*7500	6650	6.28
	lb			*31,350	*31,350	*24,050	23,100	*16,950	15,200					*16,350	14,900	20'3"



ISO 10567:2007



* Indicates that the load is limited by hydraulic lifting capacity rather than tipping load. The above loads are in compliance with hydraulic excavator lift capacity standard ISO 10567:2007. They do not exceed 87% of hydraulic lifting capacity or 75% of tipping load. Weight of all lifting accessories must be deducted from the above lifting capacities. Lifting capacities are based on the machine standing on a firm, uniform supporting surface. The use of a work tool attachment point to handle/lift objects, could affect the machine lift performance.

Lift capacity stays with ±5% for all available track shoes.

Always refer to the appropriate Operation and Maintenance Manual for specific product information.

335 Hydraulic Excavator Specifications

Reach Boom Lift Capacities – Counterweight: 5.0 mt (11,023 lb) – without Bucket, Heavy Lift: On, Blade Down

Long Undercarriage, 3600 mm (11'10") Blade

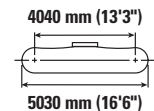
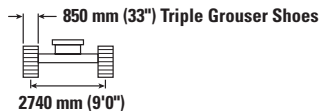
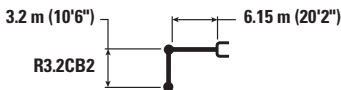

Reach	Unit	1.5 m/5.0 ft		3.0 m/10.0 ft		4.5 m/15.0 ft		6.0 m/20.0 ft		7.5 m/25.0 ft		9.0 m/30.0 ft		m ft/in		
		kg lb	kg lb	kg lb	kg lb	kg lb	kg lb	kg lb	kg lb	kg lb	kg lb	kg lb	kg lb	kg lb	kg lb	kg lb
9.0 30'0"	kg lb							*7450	*7450					*7250 *16,150	*7250 *16,150	6.04 19'3"
7.5 m 25.0 ft	kg lb							*8000 *17,600	*8000 *17,600					*6500 *14,450	*6500 *14,450	7.44 24'1"
6.0 m 20.0 ft	kg lb							*8500 *18,450	*8500 *18,450	*7950 *17,400	6450 13,900			*6250 *13,800	5400 12,000	8.33 27'2"
4.5 m 15.0 ft	kg lb			*16 950 *35,950	*16 950 *35,950	*11 750 *25,250	*11 750 *25,250	*9550 *20,700	8950 19,300	*8400 *18,250	6300 13,550			*6250 *13,800	4800 10,550	8.88 29'0"
3.0 m 10.0 ft	kg lb					*14 550 *31,300	13 250 28,550	*10 850 *23,500	8500 18,350	*9000 *19,550	6100 13,100	*7850 *14,300	4600 9,850	*6450 *14,200	4500 9,850	9.16 30'0"
1.5 m 5.0 ft	kg lb					*16 500 *35,700	12 500 26,850	*11 950 *25,850	8150 17,500	*9600 *20,750	5900 12,650	*8100 *15,900	4500 9,700	*6900 *15,150	4400 9,650	9.17 30'1"
0 m 0 ft	kg lb			*7250 *16,550	*7250 *16,550	*17 050 *36,900	12 100 26,000	*12 500 *27,050	7850 16,950	*9850 *21,300	5750 12,350			*7650 *16,800	4500 9,850	8.94 29'3"
-1.5 m -5.0 ft	kg lb	*8950 *20,000	*8950 *20,000	*13 550 *30,750	*13 550 *30,750	*16 350 *35,450	12 050 25,800	*12 250 *26,550	7750 16,700	*9550 *20,600	5650 12,200			*8100 *17,800	4850 10,700	8.43 27'7"
-3.0 m -10.0 ft	kg lb			*19 600 *42,450	*19 600 *42,450	*14 600 *31,550	12 150 26,050	*11 100 *23,900	7800 16,800	*8200	5750			*8000 *17,650	5650 12,550	7.59 24'9"
-4.5 m -15.0 ft	kg lb			*14 650 *31,350	*14 650 *31,350	*11 300 *24,050	*11 300 *24,050	*8200 *16,950	8050 *16,950					*7500 *16,350	*7500 *16,350	6.28 20'3"



ISO 10567:2007



* Indicates that the load is limited by hydraulic lifting capacity rather than tipping load. The above loads are in compliance with hydraulic excavator lift capacity standard ISO 10567:2007. They do not exceed 87% of hydraulic lifting capacity or 75% of tipping load. Weight of all lifting accessories must be deducted from the above lifting capacities. Lifting capacities are based on the machine standing on a firm, uniform supporting surface. The use of a work tool attachment point to handle/lift objects, could affect the machine lift performance.

Lift capacity stays with ±5% for all available track shoes.

Always refer to the appropriate Operation and Maintenance Manual for specific product information.

335 Hydraulic Excavator Specifications

Reach Boom Lift Capacities – Counterweight: 5.0 mt (11,023 lb) – without Bucket, Heavy Lift: On, Blade Up

Long Undercarriage, 3440 mm (11'3") Blade

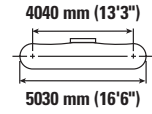
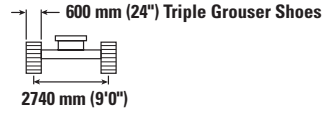
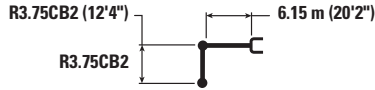

Reach	Unit	1.5 m/5.0 ft		3.0 m/10.0 ft		4.5 m/15.0 ft		6.0 m/20.0 ft		7.5 m/25.0 ft		9.0 m/30.0 ft		m		ft/in	
		kg	lb	kg	lb	kg	lb	kg	lb	kg	lb	kg	lb	kg	lb		
9.0 30'0"	kg																
	lb																
7.5 m 25.0 ft	kg																
	lb																
6.0 m 20.0 ft	kg																
	lb																
4.5 m 15.0 ft	kg																
	lb																
3.0 m 10.0 ft	kg																
	lb																
1.5 m 5.0 ft	kg																
	lb																
0 m 0 ft	kg																
	lb																
-1.5 m -5.0 ft	kg																
	lb																
-3.0 m -10.0 ft	kg																
	lb																
-4.5 m -15.0 ft	kg																
	lb																



ISO 10567:2007



* Indicates that the load is limited by hydraulic lifting capacity rather than tipping load. The above loads are in compliance with hydraulic excavator lift capacity standard ISO 10567:2007. They do not exceed 87% of hydraulic lifting capacity or 75% of tipping load. Weight of all lifting accessories must be deducted from the above lifting capacities. Lifting capacities are based on the machine standing on a firm, uniform supporting surface. The use of a work tool attachment point to handle/lift objects, could affect the machine lift performance.

Lift capacity stays with ±5% for all available track shoes.

Always refer to the appropriate Operation and Maintenance Manual for specific product information.

335 Hydraulic Excavator Specifications

Reach Boom Lift Capacities – Counterweight: 5.0 mt (11,023 lb) – without Bucket, Heavy Lift: On, Blade Down

Long Undercarriage, 3440 mm (11'3") Blade

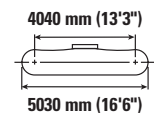
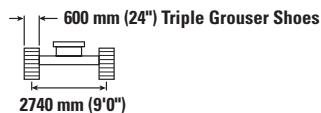
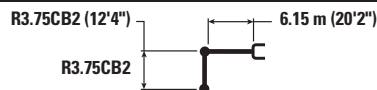

Reach	Unit	1.5 m/5.0 ft		3.0 m/10.0 ft		4.5 m/15.0 ft		6.0 m/20.0 ft		7.5 m/25.0 ft		9.0 m/30.0 ft		m		ft/in
		kg	lb	kg	lb	kg	lb	kg	lb	kg	lb	kg	lb	kg	lb	
9.0 30'0"	kg													*6050	*6050	6.78
	lb							*16,500	*16,500					*13,500	*13,500	21'8"
7.5 m 25.0 ft	kg									*7200	6150			*5550	5400	8.04
	lb									*15,100	13,100			*12,250	12,100	26'1"
6.0 m 20.0 ft	kg							*7700	*7700	*7300	6050			*5350	4500	8.88
	lb							*16,750	*16,750	*16,000	13,000			*11,800	10,000	28'11"
4.5 m 15.0 ft	kg					*10 500	*10 500	*8800	8450	*7850	5900	*7250	4350	*5400	4000	9.39
	lb					*22,550	*22,550	*19,050	18,150	*17,050	12,650	*14,600	9,250	*11,800	8,850	30'8"
3.0 m 10.0 ft	kg					*13 400	12 500	*10 200	7950	*8550	5650	*7550	4200	*5550	3750	9.65
	lb					*28,800	26,900	*22,000	17,150	*18,550	12,100	*16,450	9,050	*12,200	8,250	31'7"
1.5 m 5.0 ft	kg					*15 750	11 600	*11 450	7500	*9200	5400	*7850	4100	*5900	3650	9.67
	lb					*34,000	24,950	*24,750	16,150	*20,000	11,600	*17,050	8,800	*12,950	8,050	31'8"
0 m 0 ft	kg			*8300	*8300	*16 800	11 100	*12 200	7200	*9650	5200	*7950	4000	*6450	3750	9.45
	lb			*18,950	*18,950	*36,350	23,800	*26,450	15,450	*20,900	11,200	*17,150	8,600	*14,250	8,200	30'11"
-1.5 m -5.0 ft	kg	*8350	*8350	*12 900	*12 900	*16 600	10 900	*12 300	7050	*9600	5100			*7450	4000	8.97
	lb	*18,600	*18,600	*29,200	*29,200	*35,950	23,400	*26,600	15,100	*20,750	11,000			*16,400	8,800	29'4"
-3.0 m -10.0 ft	kg	*13 400	*13 400	*19 150	*19 150	*15 250	10 950	*11 500	7000	*8800	5100			*7600	4600	8.18
	lb	*30,050	*30,050	*43,450	*43,450	*33,000	23,450	*24,800	15,100	*18,850	11,050			*16,800	10,100	26'8"
-4.5 m -15.0 ft	kg			*17 050	*17 050	*12 650	11 150	*9450	7200					*7400	5850	6.99
	lb			*36,600	*36,600	*27,050	24,000	*20,050	15,450					*16,200	13,050	22'8"



ISO 10567:2007



* Indicates that the load is limited by hydraulic lifting capacity rather than tipping load. The above loads are in compliance with hydraulic excavator lift capacity standard ISO 10567:2007. They do not exceed 87% of hydraulic lifting capacity or 75% of tipping load. Weight of all lifting accessories must be deducted from the above lifting capacities. Lifting capacities are based on the machine standing on a firm, uniform supporting surface. The use of a work tool attachment point to handle/lift objects, could affect the machine lift performance.

Lift capacity stays with ±5% for all available track shoes.









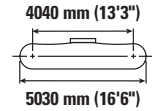
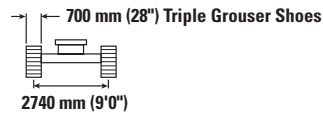
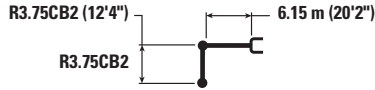





Always refer to the appropriate Operation and Maintenance Manual for specific product information.

335 Hydraulic Excavator Specifications

Reach Boom Lift Capacities – Counterweight: 5.0 mt (11,023 lb) – without Bucket, Heavy Lift: On, Blade Up

Long Undercarriage, 3440 mm (11'3") Blade



		1.5 m/5.0 ft		3.0 m/10.0 ft		4.5 m/15.0 ft		6.0 m/20.0 ft		7.5 m/25.0 ft		9.0 m/30.0 ft				m ft/in	
																	
9.0 30'0"	kg lb							*16,500	*16,500					*6050 *13,500	*6050 *13,500	6.78 21'8"	
7.5 m 25.0 ft	kg lb								*7200 *15,100	5650 12,100				*5550 *12,250	5000 11,150	8.04 26'1"	
6.0 m 20.0 ft	kg lb							*7700 *16,750	*7700 *16,750	5600 12,000				*7300 *11,800	5600 9,200	8.88 28'11"	
4.5 m 15.0 ft	kg lb			*10 500 *22,550	*10 500 *22,550	*8800 *19,050	7750 16,700	*7850 *16,850	5400 11,650	5750 12,350	4000 8,500			5350 *11,800	3700 8,150	9.39 30'8"	
3.0 m 10.0 ft	kg lb			*13 400 *28,800	11 400 24,500	*10 200 *22,000	7300 15,700	7600 16,300	5200 11,150	5650 12,100	3850 8,300			5050 11,100	3450 7,550	9.65 31'7"	
1.5 m 5.0 ft	kg lb			*15 750 *34,000	10 500 22,550	10 400 22,350	6850 14,750	7300 15,700	4950 10,650	5500 11,850	3750 8,050			4950 10,850	3350 7,350	9.67 31'8"	
0 m 0 ft	kg lb		*8300 *18,950	*8300 *18,950	16 350 35,000	10 000 21,500	10 050 21,550	6550 14,100	7100 15,300	4750 10,250	5400 11,650			3650 7,850	5050 11,100	3400 7,500	9.45 30'11"
-1.5 m -5.0 ft	kg lb	*8350 *18,600	*12 900 *29,200	*12 900 *29,200	16 150 34,500	9800 21,100	9850 21,150	6400 13,750	7000 15,050	4650 10,000				5400 11,950	3650 8,050	8.97 29'4"	
-3.0 m -10.0 ft	kg lb	*13 400 *30,050	*19 150 *43,450	*19 150 *43,450	*15 250 *33,000	9850 21,150	9850 21,150	6400 13,750	7000 15,100	4650 10,050				6200 13,750	4200 9,250	8.18 26'8"	
-4.5 m -15.0 ft	kg lb		*17 050 *36,600	*17 050 *36,600	*12 650 *27,050	10 050 21,650	*9450 *20,050	6550 14,100						*7400 *16,200	5350 11,900	6.99 22'8"	



ISO 10567:2007



* Indicates that the load is limited by hydraulic lifting capacity rather than tipping load. The above loads are in compliance with hydraulic excavator lift capacity standard ISO 10567:2007. They do not exceed 87% of hydraulic lifting capacity or 75% of tipping load. Weight of all lifting accessories must be deducted from the above lifting capacities. Lifting capacities are based on the machine standing on a firm, uniform supporting surface. The use of a work tool attachment point to handle/lift objects, could affect the machine lift performance.

Lift capacity stays with ±5% for all available track shoes.

Always refer to the appropriate Operation and Maintenance Manual for specific product information.

335 Hydraulic Excavator Specifications

Reach Boom Lift Capacities – Counterweight: 5.0 mt (11,023 lb) – without Bucket, Heavy Lift: On, Blade Down

Long Undercarriage, 3440 mm (11'3") Blade

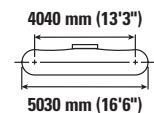
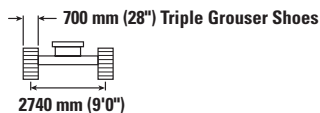
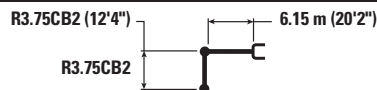

Reach	Unit	1.5 m/5.0 ft		3.0 m/10.0 ft		4.5 m/15.0 ft		6.0 m/20.0 ft		7.5 m/25.0 ft		9.0 m/30.0 ft		m		ft/in	
		kg	lb	kg	lb	kg	lb	kg	lb	kg	lb	kg	lb	kg	lb		
9.0 m 30'0"	kg																
	lb																
7.5 m 25.0 ft	kg																
	lb																
6.0 m 20.0 ft	kg																
	lb																
4.5 m 15.0 ft	kg																
	lb																
3.0 m 10.0 ft	kg																
	lb																
1.5 m 5.0 ft	kg																
	lb																
0 m 0 ft	kg																
	lb																
-1.5 m -5.0 ft	kg																
	lb																
-3.0 m -10.0 ft	kg																
	lb																
-4.5 m -15.0 ft	kg																
	lb																



ISO 10567:2007



* Indicates that the load is limited by hydraulic lifting capacity rather than tipping load. The above loads are in compliance with hydraulic excavator lift capacity standard ISO 10567:2007. They do not exceed 87% of hydraulic lifting capacity or 75% of tipping load. Weight of all lifting accessories must be deducted from the above lifting capacities. Lifting capacities are based on the machine standing on a firm, uniform supporting surface. The use of a work tool attachment point to handle/lift objects, could affect the machine lift performance.

Lift capacity stays with ±5% for all available track shoes.

Always refer to the appropriate Operation and Maintenance Manual for specific product information.

335 Hydraulic Excavator Specifications

Reach Boom Lift Capacities – Counterweight: 5.0 mt (11,023 lb) – without Bucket, Heavy Lift: On, Blade Up

Long Undercarriage, 3600 mm (11'10") Blade

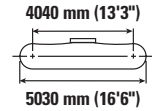
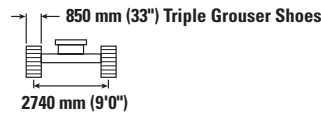
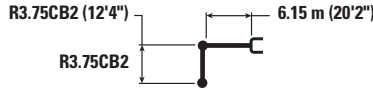

Reach	Unit	1.5 m/5.0 ft		3.0 m/10.0 ft		4.5 m/15.0 ft		6.0 m/20.0 ft		7.5 m/25.0 ft		9.0 m/30.0 ft		m		ft/in	
		kg	lb	kg	lb	kg	lb	kg	lb	kg	lb	kg	lb	kg	lb		
9.0 30'0"	kg																
	lb																
7.5 m 25.0 ft	kg																
	lb																
6.0 m 20.0 ft	kg																
	lb																
4.5 m 15.0 ft	kg																
	lb																
3.0 m 10.0 ft	kg																
	lb																
1.5 m 5.0 ft	kg																
	lb																
0 m 0 ft	kg																
	lb																
-1.5 m -5.0 ft	kg																
	lb																
-3.0 m -10.0 ft	kg																
	lb																
-4.5 m -15.0 ft	kg																
	lb																



ISO 10567:2007



* Indicates that the load is limited by hydraulic lifting capacity rather than tipping load. The above loads are in compliance with hydraulic excavator lift capacity standard ISO 10567:2007. They do not exceed 87% of hydraulic lifting capacity or 75% of tipping load. Weight of all lifting accessories must be deducted from the above lifting capacities. Lifting capacities are based on the machine standing on a firm, uniform supporting surface. The use of a work tool attachment point to handle/lift objects, could affect the machine lift performance.

Lift capacity stays with ±5% for all available track shoes.

Always refer to the appropriate Operation and Maintenance Manual for specific product information.

335 Hydraulic Excavator Specifications

Reach Boom Lift Capacities – Counterweight: 5.0 mt (11,023 lb) – without Bucket, Heavy Lift: On, Blade Down

Long Undercarriage, 3600 mm (11'10") Blade

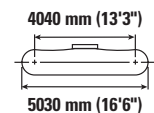
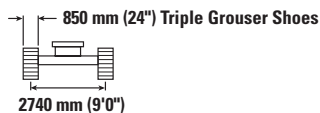
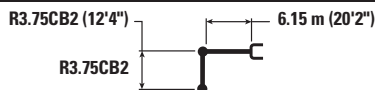

Reach	Unit	1.5 m/5.0 ft		3.0 m/10.0 ft		4.5 m/15.0 ft		6.0 m/20.0 ft		7.5 m/25.0 ft		9.0 m/30.0 ft		m ft/in		
		kg lb	kg lb	kg lb	kg lb	kg lb	kg lb	kg lb	kg lb	kg lb	kg lb	kg lb	kg lb	kg lb	kg lb	kg lb
9.0 30'0"	kg lb													*6050 *13,500	*6050 *13,500	6.78 21'8"
7.5 m 25.0 ft	kg lb									*7200 *15,100	6600 14,100			*5550 *12,250	*5550 *12,250	8.04 26'1"
6.0 m 20.0 ft	kg lb							*7700 *16,750	*7700 *16,750	*7300 *16,000	6500 14,000			*5350 *11,800	4850 10,800	8.88 28'11"
4.5 m 15.0 ft	kg lb					*10 500 *22,550	*10 500 *22,550	*8800 *19,050	*8800 *19,050	*7850 *17,050	6350 13,600	*7250 *14,600	4700 10,050	*5400 *11,800	4350 9,600	9.39 30'8"
3.0 m 10.0 ft	kg lb					*13 400 *28,800	*13 400 *28,800	*10 200 *22,000	8600 18,450	*8550 *18,550	6100 13,100	*7550 *16,450	4550 9,800	*5550 *12,200	4100 8,950	9.65 31'7"
1.5 m 5.0 ft	kg lb					*15 750 *34,000	12550 27,000	*11 450 *24,750	8150 17,500	*9200 *20,000	5850 12,550	*7850 *17,050	4450 9,550	*5900 *12,950	4000 8,750	9.67 31'8"
0 m 0 ft	kg lb			*8300 *18,950	*8300 *18,950	*16 800 *36,350	12050 25,850	*12 200 *26,450	7800 16,800	*9650 *20,900	5650 12,150	*7950 *17,150	4350 9,350	*6450 *14,250	4050 8,950	9.45 30'11"
-1.5 m -5.0 ft	kg lb	*8350 *18,600	*8350 *18,600	*12 900 *29,200	*12 900 *29,200	*16 600 *35,950	11850 25,450	*12 300 *26,600	7650 16,450	*9600 *20,750	5550 11,950			*7450 *16,400	4350 9,600	8.97 29'4"
-3.0 m -10.0 ft	kg lb	*13 400 *30,050	*13 400 *30,050	*19 150 *43,450	*19 150 *43,450	*15 250 *33,000	11900 25,550	*11 500 *24,800	7650 16,400	*8800 *18,850	5550 12,000			*7600 *16,800	4950 11,000	8.18 26'8"
-4.5 m -15.0 ft	kg lb			*17 050 *36,600	*17 050 *36,600	*12 650 *27,050	12150 26,050	*9450 *20,050	7800 16,800					*7400 *16,200	6300 14,150	6.99 22'8"



ISO 10567:2007



* Indicates that the load is limited by hydraulic lifting capacity rather than tipping load. The above loads are in compliance with hydraulic excavator lift capacity standard ISO 10567:2007. They do not exceed 87% of hydraulic lifting capacity or 75% of tipping load. Weight of all lifting accessories must be deducted from the above lifting capacities. Lifting capacities are based on the machine standing on a firm, uniform supporting surface. The use of a work tool attachment point to handle/lift objects, could affect the machine lift performance.

Lift capacity stays with ±5% for all available track shoes.

Always refer to the appropriate Operation and Maintenance Manual for specific product information.

335 Hydraulic Excavator Specifications

Bucket Specifications and Compatibility – North America

		Counterweight							5.0 mt (11,020 lb)				7.7 mt (16,980 lb)	
		Width		Capacity		Weight		Fill	With 3440 mm (11'3") Blade (Up)		With 3600 mm (11'10") Blade (Up)		Without Blade	
									R3.2 (10'6")	R3.75 (12'4")	R3.2 (10'6")	R3.75 (12'4")	R3.2 (10'6")	R3.75 (12'4")
Linkage		mm	in	m ³	yd ³	kg	lb	%	Reach Boom				Reach Boom	
		Pin-On (Without Quick Coupler)												
General Duty Capacity	CB	600	24	0.63	0.83	700	1,543	100	●	●	●	●	●	●
	CB	750	30	0.86	1.13	836	1,843	100	●	●	●	●	●	●
	CB	900	36	1.09	1.43	943	2,079	100	●	●	●	●	●	●
	CB	1050	42	1.34	1.75	1011	2,229	100	●	⊖	●	⊙	●	●
	CB	1200	48	1.58	2.07	1106	2,439	100	⊖	○	⊙	⊖	⊙	⊖
	CB	1350	54	1.83	2.40	1202	2,650	100	○	○	⊖	○	⊖	○
General Duty Capacity Wide Tips	CB	600	24	0.63	0.83	697	1,537	100	●	●	●	●	●	●
	CB	750	30	0.86	1.13	834	1,839	100	●	●	●	●	●	●
	CB	900	36	1.09	1.43	941	2,075	100	●	●	●	●	●	●
	CB	1050	42	1.34	1.75	1008	2,223	100	●	⊙	●	⊙	●	●
	CB	1200	48	1.58	2.07	1104	2,434	100	⊖	○	⊙	⊖	⊙	⊖
	CB	1350	54	1.83	2.40	1199	2,644	100	○	○	⊖	○	⊖	○
Heavy Duty	CB	600	24	0.52	0.68	730	1,608	100	●	●	●	●	●	●
	CB	750	30	0.71	0.93	848	1,869	100	●	●	●	●	●	●
	CB	900	36	0.91	1.19	941	2,075	100	●	●	●	●	●	●
	CB	1050	42	1.12	1.46	1035	2,283	100	●	●	●	●	●	●
	CB	1200	48	1.33	1.74	1107	2,440	100	⊙	⊖	●	⊙	●	⊙
	CB	1350	54	1.54	2.02	1205	2,657	100	⊖	○	⊙	⊖	⊙	⊖
	CB	1500	60	1.76	2.30	1298	2,861	100	○	◇	⊖	○	⊖	○
	CB	1650	66	1.97	2.58	1375	3,031	100	○	◇	○	◇	⊖	○
Heavy Duty Power	CB	1050	42	1.12	1.47	1065	2,347	100	●	⊙	●	●	●	●
	CB	1200	48	1.33	1.73	1143	2,519	100	⊙	⊖	●	⊙	●	⊙
	CB	1350	54	1.53	2.01	1246	2,748	100	⊖	○	⊙	⊖	⊙	⊖
Severe Duty	CB	600	24	0.52	0.68	752	1,657	90	●	●	●	●	●	●
	CB	750	30	0.71	0.93	912	2,010	90	●	●	●	●	●	●
	CB	900	36	0.91	1.19	995	2,194	90	●	●	●	●	●	●
	CB	1050	42	1.12	1.46	1094	2,411	90	●	●	●	●	●	●
	CB	1200	48	1.33	1.74	1172	2,583	90	●	⊙	●	⊙	●	●
Maximum load with pin-on (payload + bucket)								kg	3735	3300	3974	3522	4210	3740
								lb	8,234	7,275	8,761	7,764	9,281	8,245

The above loads are in compliance with hydraulic excavator standard EN474, they do not exceed 87% of hydraulic lifting capacity or 75% of tipping capacity with front linkage fully extended at ground line with bucket curled. If equipped with blade, blade is considered on the ground.

Capacity based on ISO 7451:2007.

Bucket weight with General Duty tips.

Maximum Material Density:

- 2100 kg/m³ (3,500 lb/yd³)
- ⊙ 1800 kg/m³ (3,000 lb/yd³)
- ⊖ 1500 kg/m³ (2,500 lb/yd³)
- 1200 kg/m³ (2,000 lb/yd³)
- ◇ 900 kg/m³ (1,500 lb/yd³)

Caterpillar recommends using appropriate work tools to maximize the value customers receive from our products. Use of work tools, including buckets, which are outside of Caterpillar's recommendations or specifications for weight, dimensions, flows, pressures, etc. may result in less-than-optimal performance, including but not limited to reductions in production, stability, reliability, and component durability. Improper use of a work tool resulting in sweeping, prying, twisting and/or catching of heavy loads will reduce the life of the boom and stick.

(continued on next page)

335 Hydraulic Excavator Specifications

Bucket Specifications and Compatibility – North America (continued)

	Linkage	Counterweight							5.0 mt (11,020 lb)				7.7 mt (16,980 lb)	
		Width		Capacity		Weight		Fill	With 3440 mm (11'3") Blade (Up)		With 3600 mm (11'10") Blade (Up)		Without Blade	
		mm	in	m ³	yd ³	kg	lb		%	R3.2 (10'6")	R3.75 (12'4")	R3.2 (10'6")	R3.75 (12'4")	R3.2 (10'6")
With Cat Pin Grabber Coupler														
General Duty Capacity	CB	600	24	0.63	0.83	700	1,543	100	●	●			●	●
	CB	750	30	0.86	1.13	836	1,843	100	●	●	●	●	●	●
	CB	900	36	1.09	1.43	943	2,079	100	●	⊖	●	⊙	●	●
	CB	1050	42	1.34	1.75	1011	2,229	100	⊖	○	⊙	⊖	⊙	⊖
	CB	1200	48	1.58	2.07	1106	2,439	100	○	◇	⊖	○	⊖	○
	CB	1350	54	1.83	2.40	1202	2,650	100	◇	◇	○	◇	○	◇
General Duty Capacity Wide Tips	CB	600	24	0.63	0.83	697	1,537	100	●	●	●	●	●	●
	CB	750	30	0.86	1.13	834	1,839	100	●	●	●	●	●	●
	CB	900	36	1.09	1.43	941	2,075	100	●	⊖	●	⊙	●	●
	CB	1050	42	1.34	1.75	1008	2,223	100	⊖	○	⊙	⊖	●	⊖
	CB	1200	48	1.58	2.07	1104	2,434	100	○	◇	⊖	○	⊖	○
	CB	1350	54	1.83	2.40	1199	2,644	100	◇	◇	○	◇	○	◇
Heavy Duty	CB	600	24	0.52	0.68	730	1,608	100	●	●	●	●	●	●
	CB	750	30	0.71	0.93	848	1,869	100	●	●	●	●	●	●
	CB	900	36	0.91	1.19	941	2,075	100	●	●	●	●	●	●
	CB	1050	42	1.12	1.46	1035	2,283	100	⊙	⊖	●	⊙	●	⊙
	CB	1200	48	1.33	1.74	1107	2,440	100	⊖	○	⊙	○	⊙	⊖
	CB	1350	54	1.54	2.02	1205	2,657	100	○	◇	⊖	○	⊖	○
	CB	1500	60	1.76	2.30	1298	2,861	100	◇	X	○	◇	○	◇
	CB	1650	66	1.97	2.58	1375	3,031	100	◇	X	◇	X	○	◇
Heavy Duty Power	CB	1050	42	1.12	1.47	1065	2,347	100	⊙	⊖	●	⊙	●	⊙
	CB	1200	48	1.33	1.73	1143	2,519	100	⊖	○	⊙	○	⊙	⊖
	CB	1350	54	1.53	2.01	1246	2,748	100	○	◇	⊖	○	⊖	○
Heavy Duty Pin Grabber Performance	CB	750	30	0.70	0.91	876	1,931	100	●	●	●	●	●	●
	CB	1050	42	1.08	1.42	1105	2,436	100	⊙	⊖	●	⊙	●	⊙
	CB	1200	48	1.28	1.68	1186	2,614	100	⊖	○	⊙	○	⊙	⊖
	CB	1350	54	1.49	1.94	1292	2,849	100	○	◇	⊖	○	⊖	○
	CB	1500	60	1.69	2.21	1398	3,082	100	◇	X	○	◇	○	◇
Severe Duty	CB	600	24	0.52	0.68	752	1,657	90	●	●	●	●	●	●
	CB	750	30	0.71	0.93	912	2,010	90	●	●	●	●	●	●
	CB	900	36	0.91	1.19	995	2,194	90	●	●	●	●	●	●
	CB	1050	42	1.12	1.46	1094	2,411	90	●	⊖	●	⊙	●	●
	CB	1200	48	1.33	1.74	1172	2,583	90	⊖	○	⊙	⊖	●	⊖
Severe Duty Pin Grabber Performance	CB	600	24	0.51	0.66	829	1,828	90	●	●	●	●	●	●
	CB	900	36	0.88	1.16	1057	2,331	90	●	●	●	●	●	●
	CB	1050	42	1.08	1.42	1165	2,568	90	●	⊖	●	⊙	●	●
	CB	1200	48	1.28	1.68	1252	2,760	100	⊖	○	⊙	○	⊙	⊖
Maximum load with coupler (payload + bucket)								kg	3209	2774	3447	2996	3684	3214
								lb	7,074	6,115	7,600	6,604	8,121	7,085

The above loads are in compliance with hydraulic excavator standard EN474, they do not exceed 87% of hydraulic lifting capacity or 75% of tipping capacity with front linkage fully extended at ground line with bucket curled. If equipped with blade, blade is considered on the ground.

Capacity based on ISO 7451:2007.

Bucket weight with General Duty tips.

Maximum Material Density:

- 2100 kg/m³ (3,500 lb/yd³)
- ⊙ 1800 kg/m³ (3,000 lb/yd³)
- ⊖ 1500 kg/m³ (2,500 lb/yd³)
- 1200 kg/m³ (2,000 lb/yd³)
- ◇ 900 kg/m³ (1,500 lb/yd³)
- X Not Recommended

335 Hydraulic Excavator Specifications

Bucket Specifications and Compatibility – North America (continued)

		Counterweight							5.0 mt (11,020 lb)				7.7 mt (16,980 lb)	
		Width		Capacity		Weight		Fill	With 3440 mm (11'3") Blade (Up)		With 3600 mm (11'10") Blade (Up)		Without Blade	
									R3.2 (10'6")	R3.75 (12'4")	R3.2 (10'6")	R3.75 (12'4")	R3.2 (10'6")	R3.75 (12'4")
Linkage		mm	in	m ³	yd ³	kg	lb	%	Reach Boom				Reach Boom	
		PIN-ON TRS23 S70												
Heavy Duty – Grading	CB	2000	79	1.60	2.09	1004	2,213	100	○	◇	○	◇	⊖	○
Heavy Duty – Digging	CB	1500	59	1.50	1.96	1289	2,842	100	◇	X	○	◇	○	◇
	CB	1580	62	1.60	2.09	1339	2,952	100	◇	X	◇	X	○	◇
Maximum load with pin-on (payload + bucket)								kg	2868	2433	3107	2655	3343	2873
								lb	6,323	5,364	6,849	5,853	7,370	6,334
With S70 TRS23 S70														
Heavy Duty – Grading	CB	2000	79	1.60	2.09	1004	2,213	100	◇	X	○	◇	○	◇
Heavy Duty – Digging	CB	1500	59	1.50	1.96	1289	2,842	100	◇	X	◇	X	○	◇
	CB	1580	62	1.60	2.09	1339	2,952	100	X	X	◇	X	◇	X
Maximum load with pin-on (payload + bucket)								kg	2644	2209	2883	2431	3119	2649
								lb	5,829	4,870	6,355	5,359	6,876	5,840
PIN-ON TRS23 S80														
Heavy Duty – Grading	CB	2000	79	1.60	2.09	1084	2,390	100	◇	X	○	◇	○	◇
Heavy Duty – Digging	CB	1500	59	1.50	1.96	1340	2,954	100	◇	X	◇	X	○	◇
	CB	1580	62	1.60	2.09	1390	3,064	100	◇	X	◇	X	○	◇
Maximum load with pin-on (payload + bucket)								kg	2785	2350	3024	2572	3260	2790
								lb	6,140	5,181	6,666	5,670	7,187	6,151
With S80 TRS23 S80														
Heavy Duty – Grading	CB	2000	79	1.60	2.09	1084	2,390	100	X	X	◇	X	◇	X
Heavy Duty – Digging	CB	1500	59	1.50	1.96	1340	2,954	100	X	X	X	X	◇	X
	CB	1580	62	1.60	2.09	1390	3,064	100	X	X	X	X	◇	X
Maximum load with pin-on (payload + bucket)								kg	2367	1932	2606	2154	2842	2372
								lb	5,218	4,259	5,745	4,748	6,266	5,229

The above loads are in compliance with hydraulic excavator standard EN474, they do not exceed 87% of hydraulic lifting capacity or 75% of tipping capacity with front linkage fully extended at ground line with bucket curled. If equipped with blade, blade is considered on the ground.

Capacity based on ISO 7451:2007.

Bucket weight with General Duty tips.

Maximum Material Density:

⊖ 1500 kg/m³ (2,500 lb/yd³)

○ 1200 kg/m³ (2,000 lb/yd³)

◇ 900 kg/m³ (1,500 lb/yd³)

X Not Recommended

335 Hydraulic Excavator Specifications

Bucket Specifications and Compatibility – Europe

		Counterweight							5.0 mt (11,020 lb)				7.7 mt (16,980 lb)		
		Width		Capacity		Weight		Fill	With 3440 mm (11'3") Blade (Up)		With 3600 mm (11'10") Blade (Up)		Without Blade		
	Linkage	mm	in	m ³	yd ³	kg	lb	%	Reach Boom				Reach Boom		
									R3.2 (10'6")	R3.75 (12'4")	R3.2 (10'6")	R3.75 (12'4")	R3.2 (10'6")	R3.75 (12'4")	
Pin-On (Without Quick Coupler)															
General Duty	CB	750	30	0.71	0.93	733	1,616	100	●	●	●	●	●	●	
	CB	1050	42	1.12	1.46	874	1,927	100	●	●	●	●	●	●	
	CB	1200	48	1.33	1.74	938	2,068	100	●	⊙	●	⊙	●	●	
	CB	1350	54	1.54	2.02	1024	2,258	100	⊙	⊖	⊙	⊖	●	⊙	
	CB	1500	60	1.76	2.30	1088	2,399	100	⊖	○	⊖	○	⊙	⊖	
General Duty – No Bucket Adjuster	CB	600	24	0.52	0.68	611	1,347	100	●	●	●	●	●	●	
	CB	1000	40	1.03	1.35	844	1,861	100	●	●	●	●	●	●	
	CB	1350	54	1.54	2.01	1018	2,245	100	⊙	⊖	⊙	⊖	●	⊙	
	CB	1500	60	1.76	2.30	1082	2,386	100	⊖	○	⊖	○	⊙	⊖	
	CB	1600	63	1.86	2.43	1112	2,452	100	○	○	⊖	○	⊖	○	
Heavy Duty	CB	1350	54	1.54	2.02	1142	2,518	100	⊖	○	⊙	⊖	⊙	⊖	
	CB	1500	60	1.76	2.30	1240	2,733	100	○	○	⊖	○	⊖	○	
	CB	1650	66	1.97	2.58	1312	2,892	100	○	◇	○	◇	⊖	○	
Severe Duty	CB	1350	54	1.56	2.04	1234	2,721	90	⊙	⊖	⊙	⊖	●	⊙	
Maximum load with pin-on (payload + bucket)								kg	3735	3300	3974	3522	4210	3740	
								lb	8,234	7,275	8,761	7,764	9,281	8,245	

The above loads are in compliance with hydraulic excavator standard EN474, they do not exceed 87% of hydraulic lifting capacity or 75% of tipping capacity with front linkage fully extended at ground line with bucket curled. If equipped with blade, blade is considered on the ground.

Capacity based on ISO 7451:2007.

Bucket weight with General Duty tips.

Maximum Material Density:

- 2100 kg/m³ (3,500 lb/yd³)
- ⊙ 1800 kg/m³ (3,000 lb/yd³)
- ⊖ 1500 kg/m³ (2,500 lb/yd³)
- 1200 kg/m³ (2,000 lb/yd³)
- ◇ 900 kg/m³ (1,500 lb/yd³)

Caterpillar recommends using appropriate work tools to maximize the value customers receive from our products. Use of work tools, including buckets, which are outside of Caterpillar's recommendations or specifications for weight, dimensions, flows, pressures, etc. may result in less-than-optimal performance, including but not limited to reductions in production, stability, reliability, and component durability. Improper use of a work tool resulting in sweeping, prying, twisting and/or catching of heavy loads will reduce the life of the boom and stick.

(continued on next page)

335 Hydraulic Excavator Specifications

Bucket Specifications and Compatibility – Europe (continued)

		Counterweight							5.0 mt (11,020 lb)				7.7 mt (16,980 lb)	
		Width		Capacity		Weight		Fill	With 3440 mm (11'3") Blade (Up)		With 3600 mm (11'10") Blade (Up)		Without Blade	
									R3.2 (10'6")	R3.75 (12'4")	R3.2 (10'6")	R3.75 (12'4")	R3.2 (10'6")	R3.75 (12'4")
Linkage		mm	in	m ³	yd ³	kg	lb	%	Reach Boom				Reach Boom	
		With Cat Pin Grabber Coupler												
General Duty	CB	750	30	0.71	0.93	733	1,616	100	●	●	●	●	●	●
	CB	1050	42	1.12	1.46	874	1,927	100	●	⊖	●	⊙	●	●
	CB	1200	48	1.33	1.74	938	2,068	100	⊖	○	⊙	⊖	●	⊙
	CB	1350	54	1.54	2.02	1024	2,258	100	○	◇	⊖	○	⊙	○
	CB	1500	60	1.76	2.30	1088	2,399	100	○	◇	○	◇	⊖	○
General Duty – No Bucket Adjuster	CB	600	24	0.52	0.68	611	1,347	100	●	●	●	●	●	●
	CB	1000	40	1.03	1.35	844	1,861	100	●	⊙	●	●	●	●
	CB	1350	54	1.54	2.01	1018	2,245	100	○	◇	⊖	○	⊙	○
	CB	1500	60	1.76	2.30	1082	2,386	100	○	◇	○	◇	⊖	○
	CB	1600	63	1.86	2.43	1112	2,452	100	◇	◇	○	◇	○	◇
Heavy Duty	CB	1350	54	1.54	2.02	1142	2,518	100	○	◇	⊖	○	⊖	○
	CB	1500	60	1.76	2.30	1240	2,733	100	◇	◇	○	◇	○	◇
	CB	1650	66	1.97	2.58	1312	2,892	100	◇	X	◇	X	○	◇
Severe Duty	CB	1350	54	1.56	2.04	1234	2,721	90	○	◇	⊖	○	⊙	○
								kg	3209	2774	3447	2996	3684	3214
								lb	7,074	6,115	7,600	6,604	8,121	7,085

The above loads are in compliance with hydraulic excavator standard EN474, they do not exceed 87% of hydraulic lifting capacity or 75% of tipping capacity with front linkage fully extended at ground line with bucket curled. If equipped with blade, blade is considered on the ground.

Capacity based on ISO 7451:2007.

Bucket weight with General Duty tips.

Maximum Material Density:

- 2100 kg/m³ (3,500 lb/yd³)
- ⊙ 1800 kg/m³ (3,000 lb/yd³)
- ⊖ 1500 kg/m³ (2,500 lb/yd³)
- 1200 kg/m³ (2,000 lb/yd³)
- ◇ 900 kg/m³ (1,500 lb/yd³)
- X Not Recommended

Caterpillar recommends using appropriate work tools to maximize the value customers receive from our products. Use of work tools, including buckets, which are outside of Caterpillar's recommendations or specifications for weight, dimensions, flows, pressures, etc. may result in less-than-optimal performance, including but not limited to reductions in production, stability, reliability, and component durability. Improper use of a work tool resulting in sweeping, prying, twisting and/or catching of heavy loads will reduce the life of the boom and stick.

(continued on next page)

335 Hydraulic Excavator Specifications

Bucket Specifications and Compatibility – Europe (continued)

		Counterweight							5.0 mt (11,020 lb)				7.7 mt (16,980 lb)	
		Width		Capacity		Weight		Fill	With 3440 mm (11'3") Blade (Up)		With 3600 mm (11'10") Blade (Up)		Without Blade	
	Linkage	Width		Capacity		Weight		%	Reach Boom				Reach Boom	
		mm	in	m ³	yd ³	kg	lb		R3.2 (10'6")	R3.75 (12'4")	R3.2 (10'6")	R3.75 (12'4")	R3.2 (10'6")	R3.75 (12'4")
With CW 40 Coupler														
General Duty	CB	750	30	0.71	0.93	641	1,413	100	●	●	●	●	●	●
	CB	1050	42	1.12	1.46	816	1,799	100	●	⊙	●	●	●	●
	CB	1200	48	1.33	1.74	880	1,940	100	⊙	⊖	●	⊙	●	⊙
	CB	1350	54	1.54	2.02	965	2,128	100	⊖	○	⊙	⊖	⊙	⊖
	CB	1500	60	1.76	2.30	1029	2,269	100	○	◇	⊖	○	⊖	○
Heavy Duty	CB	1050	42	1.12	1.46	940	2,073	100	●	⊙	●	●	●	●
	CB	1350	54	1.54	2.02	1083	2,388	100	⊖	○	⊖	○	⊙	⊖
	CB	1650	66	1.97	2.58	1253	2,762	100	◇	◇	○	◇	○	◇
Severe Duty	CB	1050	42	1.13	1.48	1008	2,223	100	●	⊙	●	⊙	●	●
	CB	1350	54	1.56	2.04	1196	2,637	100	⊖	○	⊖	○	⊙	⊖
General Duty – Leveling Edge	CB	1500	59	1.71	2.24	1066	2,350	100	○	◇	⊖	○	⊖	○
	CB	1600	63	1.86	2.43	1135	2,503	100	○	◇			⊖	○
								kg	3442	3007	3681	3229	3917	3447
								lb	7,588	6,629	8,115	7,118	8,636	7,599

The above loads are in compliance with hydraulic excavator standard EN474, they do not exceed 87% of hydraulic lifting capacity or 75% of tipping capacity with front linkage fully extended at ground line with bucket curled. If equipped with blade, blade is considered on the ground.

Capacity based on ISO 7451:2007.

Bucket weight with General Duty tips.

Maximum Material Density:

- 2100 kg/m³ (3,500 lb/yd³)
- ⊙ 1800 kg/m³ (3,000 lb/yd³)
- ⊖ 1500 kg/m³ (2,500 lb/yd³)
- 1200 kg/m³ (2,000 lb/yd³)
- ◇ 900 kg/m³ (1,500 lb/yd³)

Caterpillar recommends using appropriate work tools to maximize the value customers receive from our products. Use of work tools, including buckets, which are outside of Caterpillar's recommendations or specifications for weight, dimensions, flows, pressures, etc. may result in less-than-optimal performance, including but not limited to reductions in production, stability, reliability, and component durability. Improper use of a work tool resulting in sweeping, prying, twisting and/or catching of heavy loads will reduce the life of the boom and stick.

(continued on next page)

335 Hydraulic Excavator Specifications

Bucket Specifications and Compatibility – Europe (continued)

		Counterweight							5.0 mt (11,020 lb)				7.7 mt (16,980 lb)		
		Width		Capacity		Weight		Fill	With 3440 mm (11'3") Blade (Up)		With 3600 mm (11'10") Blade (Up)		Without Blade		
	Linkage	mm	in	m ³	yd ³	kg	lb	%	R3.2 (10'6")	R3.75 (12'4")	R3.2 (10'6")	R3.75 (12'4")	R3.2 (10'6")	R3.75 (12'4")	
										Reach Boom				Reach Boom	
With CW 45 Coupler															
Heavy Duty	CB	1350	54	1.54	2.02	1143	2,520	100	○	◇	⊖	○	⊖	○	
	CB	1500	60	1.76	2.30	1240	2,733	100	○	◇	○	◇	⊖	○	
	CB	1650	66	1.97	2.58	1313	2,894	100	◇	X	◇	◇	○	◇	
								kg	3300	2865	3539	3087	3775	3305	
								lb	7,275	6,316	7,801	6,805	8,322	7,286	
With CW 45S Coupler															
General Duty	CB	750	30	0.71	0.93	719	1,585	100	●	●	●	●	●	●	
	CB	1350	54	1.54	2.02	1021	2,251	100	⊖	○	⊖	○	⊖	○	
	CB	1500	60	1.76	2.30	1086	2,394	100	○	◇	○	◇	⊖	○	
General Duty – Leveling Edge	CB	1500	59	1.71	2.24	1109	2,445	100	○	◇	○	○	⊖	○	
	CB	1600	63	1.86	2.43	1177	2,595	100	○	◇	○	◇	○	○	
	CB	1500	59	1.71	2.24	1116	2,461	100	○	◇	○	○	⊖	○	
Heavy Duty	CB	1600	63	1.86	2.43	1186	2,615	100	○	◇	○	◇	○	○	
	CB	1050	42	1.12	1.46	994	2,192	100	●	⊖	●	⊖	●	●	
	CB	1350	54	1.54	2.02	1139	2,512	100	○	◇	⊖	○	⊖	○	
Maximum load with coupler (payload + bucket)	kg								3330	2895	3569	3117	3805	3335	
	lb								7,341	6,382	7,868	6,871	8,389	7,352	
PIN-ON TRS23 S70															
Heavy Duty – Grading	CB	2000	79	1.60	2.09	1004	2,213	100	○	◇	○	◇	⊖	○	
Heavy Duty – Digging	CB	1500	59	1.50	1.96	1289	2,842	100	◇	X	○	◇	○	◇	
	CB	1580	62	1.60	2.09	1339	2,952	100	◇	X	◇	X	○	◇	
								kg	2868	2433	3107	2655	3343	2873	
								lb	6,323	5,364	6,849	5,853	7,370	6,334	
With S70 TRS23 S70															
Heavy Duty – Grading	CB	2000	79	1.60	2.09	1004	2,213	100	◇	X	○	◇	○	◇	
Heavy Duty – Digging	CB	1500	59	1.50	1.96	1289	2,842	100	◇	X	◇	X	○	◇	
	CB	1580	62	1.60	2.09	1339	2,952	100	X	X	◇	X	◇	X	
								kg	2644	2209	2883	2431	3119	2649	
								lb	5,829	4,870	6,355	5,359	6,876	5,840	

The above loads are in compliance with hydraulic excavator standard EN474, they do not exceed 87% of hydraulic lifting capacity or 75% of tipping capacity with front linkage fully extended at ground line with bucket curled. If equipped with blade, blade is considered on the ground.

Capacity based on ISO 7451:2007.

Bucket weight with General Duty tips.

Maximum Material Density:

- 2100 kg/m³ (3,500 lb/yd³)
- ⊖ 1800 kg/m³ (3,000 lb/yd³)
- 1500 kg/m³ (2,500 lb/yd³)
- ◇ 1200 kg/m³ (2,000 lb/yd³)
- ◇ 900 kg/m³ (1,500 lb/yd³)
- X Not Recommended

Caterpillar recommends using appropriate work tools to maximize the value customers receive from our products. Use of work tools, including buckets, which are outside of Caterpillar's recommendations or specifications for weight, dimensions, flows, pressures, etc. may result in less-than-optimal performance, including but not limited to reductions in production, stability, reliability, and component durability. Improper use of a work tool resulting in sweeping, prying, twisting and/or catching of heavy loads will reduce the life of the boom and stick.

335 Hydraulic Excavator Specifications

Bucket Specifications and Compatibility – Europe (continued)

		Counterweight							5.0 mt (11,020 lb)				7.7 mt (16,980 lb)	
		Width		Capacity		Weight		Fill	With 3440 mm (11'3") Blade (Up)		With 3600 mm (11'10") Blade (Up)		Without Blade	
									R3.2 (10'6")	R3.75 (12'4")	R3.2 (10'6")	R3.75 (12'4")	R3.2 (10'6")	R3.75 (12'4")
Linkage		mm	in	m ³	yd ³	kg	lb	%	Reach Boom				Reach Boom	
PIN-ON TRS23 S80														
Heavy Duty – Grading	CB	2000	79	1.60	2.09	1084	2,390	100	◇	X	○		○	◇
Heavy Duty – Digging	CB	1500	59	1.50	1.96	1340	2,954	100	◇	X	◇	X	○	◇
	CB	1580	62	1.60	2.09	1390	3,064	100	◇	X	◇	X	○	◇
Maximum load with pin-on (payload + bucket)								kg	2785	2350	3024	2572	3260	2790
								lb	6,140	5,181	6,666	5,670	7,187	6,151
With S80 TRS23 S80														
Heavy Duty – Grading	CB	2000	79	1.60	2.09	1084	2,390	100	X	X	◇	X	◇	X
Heavy Duty – Digging	CB	1500	59	1.50	1.96	1340	2,954	100	X	X	X	X	◇	X
	CB	1580	62	1.60	2.09	1390	3,064	100	X	X	X	X	◇	X
Maximum load with pin-on (payload + bucket)								kg	2367	1932	2606	2154	2842	2372
								lb	5,218	4,259	5,745	4,748	6,266	5,229
PIN-ON TRS23 HCS70/55														
Heavy Duty – Grading	CB	2000	79	1.60	2.09	982	2,165	100	◇	X	○	◇	○	◇
Heavy Duty – Trenching	CB	770	30	0.85	1.11	686	1,512	100	●	⊕	●	●	●	●
Heavy Duty – Digging	CB	1500	59	1.50	1.96	1280	2,822	100	◇	X	○	X	○	◇
	CB	1580	62	1.60	2.09	1337	2,948	100	◇	X	◇	X	○	◇
Maximum load with pin-on (payload + bucket)								kg	2757	2322	2996	2544	3232	2762
								lb	6,078	5,119	6,604	5,608	7,125	6,089
HCS70/55 TRS23 HCS70/55														
Heavy Duty – Grading	CB	2000	79	1.60	2.09	982	2,165	100	◇	X	◇	X	○	◇
Heavy Duty – Trenching	CB	770	30	0.85	1.11	686	1,512	100	●	⊖	●	⊕	●	●
Heavy Duty – Digging	CB	1500	59	1.50	1.96	1280	2,822	100	X	X	◇	X	◇	X
	CB	1580	62	1.60	2.09	1337	2,948	100	X	X	X	X	◇	X
Maximum load with pin-on (payload + bucket)								kg	2406	1971	2645	2193	2881	2411
								lb	5,304	4,345	5,831	4,834	6,352	5,315

The above loads are in compliance with hydraulic excavator standard EN474, they do not exceed 87% of hydraulic lifting capacity or 75% of tipping capacity with front linkage fully extended at ground line with bucket curled. If equipped with blade, blade is considered on the ground.

Capacity based on ISO 7451:2007.

Bucket weight with General Duty tips.

Maximum Material Density:

- 2100 kg/m³ (3,500 lb/yd³)
- ⊕ 1800 kg/m³ (3,000 lb/yd³)
- ⊖ 1500 kg/m³ (2,500 lb/yd³)
- 1200 kg/m³ (2,000 lb/yd³)
- ◇ 900 kg/m³ (1,500 lb/yd³)
- X Not Recommended

Caterpillar recommends using appropriate work tools to maximize the value customers receive from our products. Use of work tools, including buckets, which are outside of Caterpillar's recommendations or specifications for weight, dimensions, flows, pressures, etc. may result in less-than-optimal performance, including but not limited to reductions in production, stability, reliability, and component durability. Improper use of a work tool resulting in sweeping, prying, twisting and/or catching of heavy loads will reduce the life of the boom and stick.

(continued on next page)

335 Hydraulic Excavator Specifications

Bucket Specifications and Compatibility – Australia and New Zealand

		Counterweight							5.0 mt (11,020 lb)				7.7 mt (16,980 lb)	
				Capacity		Weight		Fill	With 3440 mm (11'3") Blade (Up)		With 3600 mm (11'10") Blade (Up)		Without Blade	
	Linkage	Width		Capacity		Weight		%	Reach Boom				Reach Boom	
		mm	in	m ³	yd ³	kg	lb		R3.2 (10'6")	R3.75 (12'4")	R3.2 (10'6")	R3.75 (12'4")	R3.2 (10'6")	R3.75 (12'4")
Pin-On (Without Quick Coupler)														
Utility Duty	CB	600	24	0.50	0.65	593	1,307	100	●	●	●	●	●	●
	CB	900	36	0.88	1.15	787	1,735	100	●	●	●	●	●	●
	CB	1500	60	1.71	2.24	1064	2,346	100	⊖	○	⊖	⊖	●	⊖
General Duty	CB	600	24	0.52	0.68	611	1,347	100	●	●	●	●	●	●
	CB	1000	40	1.03	1.35	844	1,861	100	●	●	●	●	●	●
	CB	1350	54	1.54	2.01	1018	2,245	100	⊙	⊖	⊙	⊖	●	⊙
	CB	1500	60	1.76	2.30	1082	2,386	100	⊖	○	⊖	○	⊙	⊖
	CB	1600	63	1.86	2.43	1112	2,452	100	○	○	⊖	○	⊖	○
Heavy Duty	CB	1200	48	1.33	1.74	1091	2,405	100	⊙	⊖	●	⊙	●	⊙
	CB	1350	54	1.54	2.02	1189	2,622	100	⊖	○	⊙	⊖	⊙	⊖
	CB	1500	60	1.76	2.30	1288	2,839	100	○	○	⊖	○	⊖	○
								kg	3735	3300	3974	3522	4210	3740
Maximum load with pin-on (payload + bucket)								lb	8,234	7,275	8,761	7,764	9,281	8,245
With Cat Pin Grabber Coupler														
Utility Duty	CB	600	24	0.5	0.65	593	1,307	100	●	●	●	●	●	●
	CB	900	36	0.88	1.15	787	1,735	100	●	●	●	●	●	●
	CB	1500	60	1.71	2.24	1064	2,346	100	○	◇	○	◇	⊖	○
General Duty	CB	600	24	0.52	0.68	611	1,347	100	●	●	●	●	●	●
	CB	1000	40	1.03	1.35	844	1,861	100	●	⊙	●	●	●	●
	CB	1350	54	1.54	2.01	1018	2,245	100	○	◇	⊙	⊖	⊙	○
	CB	1500	60	1.76	2.30	1082	2,386	100	○	◇	⊖	○	⊖	○
	CB	1600	63	1.86	2.43	1112	2,452	100	◇	◇	⊖	○	○	◇
Heavy Duty	CB	1200	48	1.33	1.74	1091	2,405	100	⊖	○	●	⊙	⊙	⊖
	CB	1350	54	1.54	2.02	1189	2,622	100	○	◇	⊙	⊖	⊖	○
	CB	1500	60	1.76	2.30	1288	2,839	100	◇	X	⊖	○	○	◇
								kg	3209	2774	3447	2996	3684	3214
Maximum load with coupler (payload + bucket)								lb	7,074	6,115	7,600	6,604	8,121	7,085

The above loads are in compliance with hydraulic excavator standard EN474, they do not exceed 87% of hydraulic lifting capacity or 75% of tipping capacity with front linkage fully extended at ground line with bucket curled. If equipped with blade, blade is considered on the ground.

Capacity based on ISO 7451:2007.

Bucket weight with General Duty tips.

Maximum Material Density:

- 2100 kg/m³ (3,500 lb/yd³)
- ⊙ 1800 kg/m³ (3,000 lb/yd³)
- ⊖ 1500 kg/m³ (2,500 lb/yd³)
- 1200 kg/m³ (2,000 lb/yd³)
- ◇ 900 kg/m³ (1,500 lb/yd³)
- X Not Recommended

Caterpillar recommends using appropriate work tools to maximize the value customers receive from our products. Use of work tools, including buckets, which are outside of Caterpillar's recommendations or specifications for weight, dimensions, flows, pressures, etc. may result in less-than-optimal performance, including but not limited to reductions in production, stability, reliability, and component durability. Improper use of a work tool resulting in sweeping, prying, twisting and/or catching of heavy loads will reduce the life of the boom and stick.

335 Hydraulic Excavator Specifications

Bucket Specifications and Compatibility – Hong Kong and Taiwan

		Counterweight							5.0 mt (11,020 lb)				7.7 mt (16,980 lb)	
									With 3440 mm (11'3") Blade (Up)		With 3600 mm (11'10") Blade (Up)		Without Blade	
	Linkage	Width		Capacity		Weight		Fill	Reach Boom				Reach Boom	
		mm	in	m ³	yd ³	kg	lb	%	R3.2 (10'6")	R3.75 (12'4")	R3.2 (10'6")	R3.75 (12'4")	R3.2 (10'6")	R3.75 (12'4")
Pin-On (Without Quick Coupler)														
General Duty	CB	1700	67	2.00	2.60	1299	2,865	100	○	◇	○	◇	⊖	○
Heavy Duty	CB	1250	49	1.33	1.74	1153	2,541	100	●	⊖	●	●	●	●
	CB	1400	55	1.54	2.02	1256	2,770	100	⊖	○	●	⊖	●	⊖
	CB	1500	60	1.76	2.30	1378	3,038	100	○	◇	⊖	○	⊖	○
Maximum load with pin-on (payload + bucket)								kg	3735	3300	3974	3522	4210	3740
								lb	8,234	7,275	8,761	7,764	9,281	8,245
With Cat Pin Grabber Coupler														
General Duty	CB	1700	67	2.00	2.60	1299	2,865	100	◇	X	○	◇	○	◇
Heavy Duty	CB	1250	49	1.33	1.74	1153	2,541	100	⊖	○	●	●	●	⊖
	CB	1400	55	1.54	2.02	1256	2,770	100	○	◇	●	⊖	⊖	○
	CB	1500	60	1.76	2.30	1378	3,038	100	◇	X	⊖	○	○	◇
Maximum load with coupler (payload + bucket)								kg	3209	2774	3447	2996	3684	3214
								lb	7,074	6,115	7,600	6,604	8,121	7,085

The above loads are in compliance with hydraulic excavator standard EN474, they do not exceed 87% of hydraulic lifting capacity or 75% of tipping capacity with front linkage fully extended at ground line with bucket curled. If equipped with blade, blade is considered on the ground.

Capacity based on ISO 7451:2007.

Bucket weight with General Duty tips.

Maximum Material Density:

- 2100 kg/m³ (3,500 lb/yd³)
- 1800 kg/m³ (3,000 lb/yd³)
- ⊖ 1500 kg/m³ (2,500 lb/yd³)
- 1200 kg/m³ (2,000 lb/yd³)
- ◇ 900 kg/m³ (1,500 lb/yd³)
- X Not Recommended

Caterpillar recommends using appropriate work tools to maximize the value customers receive from our products. Use of work tools, including buckets, which are outside of Caterpillar's recommendations or specifications for weight, dimensions, flows, pressures, etc. may result in less-than-optimal performance, including but not limited to reductions in production, stability, reliability, and component durability. Improper use of a work tool resulting in sweeping, prying, twisting and/or catching of heavy loads will reduce the life of the boom and stick.

335 Hydraulic Excavator Specifications

Attachments Offering Guide – North America

Not all Attachments are available in all regions. Consult your Cat dealer for configurations available in your region.

Match
 Working range front only
 No Match
 1800 kg/m³ (3,000 lb/yd³)
 1200 kg/m³ (2,000 lb/yd³)

PIN-ON ATTACHMENTS

Counterweight	Boom Type	Stick Length	With Blade (Up)		Without Blade	
			5.0 mt (11,020 lb)		7.7 mt (16,980 lb)	
			Reach Boom		Reach Boom	
			R3.2 (10'6")	R3.75 (12'4")	R3.2 (10'6")	R3.75 (12'4")
Hydraulic Hammers		H130 GC	✓	✓	✓	✓
		H130 GC S	✓	✓	✓	✓
		H130 S	✓	✓	✓	✓
		H140 GC	✓	✓	✓	✓
		H140 GC S	✓	✓*	✓	✓
		H140 S	✓	✓	✓	✓
		H160 GC	✓	✓*	✓	✓
		H160 GC S	✓	✓	✓	✓
		H160 S	✓	✓*	✓	✓
	Multi-Processors		MP324 Concrete Cutter Jaw	✓	✓	✓
		MP324 Demolition Jaw	✓	✓	✓	✓
		MP324 Pulverizer Jaw	✓	✓	✓	✓
		MP324 Shear Jaw	✓	✓	✓	✓
		MP324 Tank Shear Jaw	✓	✓	✓	✓
		MP324 Universal Jaw	✓	✓	✓	✓
		MP332 Concrete Cutter Jaw	✓*		✓	✓*
		MP332 Demolition Jaw	✓*		✓	✓*
		MP332 Pulverizer Jaw			✓	✓*
		MP332 Shear Jaw	✓*		✓	✓*
		MP332 Tank Shear Jaw			✓*	
		MP332 Universal Jaw			✓	✓*
Demolition and Sorting Grapples		G324	✓	✓	✓	✓
		G324 WH-1500	✓	✓	✓	✓
		G324 WH-1800	✓		✓	✓
		G324 WH-2000	✓*		✓	✓*
		G332	✓	✓*	✓	✓
Mobile Scrap and Demolition Shears		S3035 Flat Top	✓*		✓	✓*
Pulverizers		P224 Secondary Pulverizer	✓	✓	✓	✓
		P324 Primary Pulverizer	✓	✓	✓	✓
		P332 Primary Pulverizer	✓*		✓	✓*
Mulchers		HM5515	✓	✓	✓	✓
		HM6015	✓	✓	✓	✓
Compactors (Vibratory Plate)		CVP110	✓	✓	✓	✓
Rotary Cutters		RC30	✓	✓	✓	✓
Orange Peel Grapples		GSH425-750	●	●	●	●
		GSH425-950	●	●	●	●
		GSH425-1150	●	○	●	●
		GSH440-950	●	○	●	●
		GSH440-1150	○		●	○
		GSH440-1550			○	
		GSH525-750	●	●	●	●
		GSH525-950	●	○	●	●
		GSH525-1150	○	○	●	○
Clamshell Grapples		CTV15-1900			○	
		CTV20-1500	○		○	○

(continued on next page)

335 Hydraulic Excavator Specifications

Attachments Offering Guide – North America (continued)

Not all Attachments are available in all regions. Consult your Cat dealer for configurations available in your region.

Match
 Working range front only
 No Match
 † Allowed usage on machine less than 50%

CAT PIN GRABBER COUPLER ATTACHMENTS

Counterweight		With Blade (Up)		Without Blade	
		5.0 mt (11,020 lb)		7.7 mt (16,980 lb)	
Boom Type		Reach Boom		Reach Boom	
Stick Length		R3.2 (10'6")	R3.75 (12'4")	R3.2 (10'6")	R3.75 (12'4")
Hydraulic Hammers	H130 GC	✓	✓	✓	✓
	H130 GC S	✓	✓	✓	✓
	H130 S	✓	✓	✓	✓
	H140 GC	✓*		✓	✓*
	H140 GC S			✓	
	H140 S	✓	✓	✓	✓
	H160 GC			✓	✓*
	H160 GC S	✓		✓	✓
	H160 S			✓	
Multi-Processors	MP324 Concrete Cutter Jaw	✓		✓	✓
	MP324 Demolition Jaw	✓*		✓	✓
	MP324 Pulverizer Jaw	✓*		✓	✓*
	MP324 Shear Jaw	✓		✓	✓
	MP324 Tank Shear Jaw	✓*		✓	✓*
	MP324 Universal Jaw	✓*		✓	✓*
	MP332 Shear Jaw			✓*	
Demolition and Sorting Grapples	G324	✓†		✓†	✓
	G324 WH-1500	✓†*		✓†	✓*
	G324 WH-1800			✓†*	
	G332			✓†	
Mobile Scrap and Demolition Shears	S3035 Flat Top			✓*	
Compactors (Vibratory Plate)	CVP110	✓	✓	✓	✓
Mulchers	HM5515 Standard	✓	✓	✓	✓
	HM6015	✓	✓	✓	✓
Rotary Cutters	RC30	✓	✓	✓	✓

(continued on next page)

335 Hydraulic Excavator Specifications

Attachments Offering Guide – North America (continued)

Not all Attachments are available in all regions. Consult your Cat dealer for configurations available in your region.

Match
 Working range front only
 No Match
 † Allowed usage on machine less than 50%

S70 DEDICATED COUPLER ATTACHMENTS

		With Blade (Up)		Without Blade	
		5.0 mt (11,020 lb)		7.7 mt (16,980 lb)	
Counterweight		Reach Boom		Reach Boom	
Boom Type		R3.2 (10'6")	R3.75 (12'4")	R3.2 (10'6")	R3.75 (12'4")
Stick Length					
Hydraulic Hammers	H130 S	✓	✓	✓	✓
	H140 S	✓	✓	✓	✓
Multi-Processors	MP324 Concrete Cutter Jaw	✓	✓*	✓	✓
	MP324 Demolition Jaw	✓	✓*	✓	✓
	MP324 Pulverizer Jaw	✓		✓	✓
	MP324 Shear Jaw	✓	✓	✓	✓
	MP324 Tank Shear Jaw	✓	✓*	✓	✓
	MP324 Universal Jaw	✓	✓*	✓	✓
Demolition and Sorting Grapples	G324	✓†	✓*	✓†	✓
	G324 WH-1500	✓†	✓*	✓†	✓
	G324 WH-1800	✓†*		✓†	✓*
	G324 WH-2000			✓†	
	G332	✓†*		✓†	✓*
Mobile Scrap and Demolition Shears	S3035 Flat Top			✓	
Pulverizers	P224 Secondary Pulverizer	✓	✓*	✓	✓
	P324 Primary Pulverizer	✓	✓*	✓	✓
Compactors (Vibratory Plate)	CVP110	✓	✓	✓	✓
Rotary Cutters	RC30	✓	✓	✓	✓

(continued on next page)

335 Hydraulic Excavator Specifications

Attachments Offering Guide – North America (continued)

Not all Attachments are available in all regions. Consult your Cat dealer for configurations available in your region.

Match
 Working range front only
 No Match
 † Allowed usage on machine less than 50%

S80 DEDICATED COUPLER ATTACHMENTS

		With Blade (Up)		Without Blade	
		5.0 mt (11,020 lb)		7.7 mt (16,980 lb)	
Counterweight		Reach Boom		Reach Boom	
Boom Type		R3.2 (10'6")	R3.75 (12'4")	R3.2 (10'6")	R3.75 (12'4")
Stick Length		R3.2 (10'6")	R3.75 (12'4")	R3.2 (10'6")	R3.75 (12'4")
Hydraulic Hammers	H130 GC S	✓	✓	✓	✓
	H130 S	✓	✓	✓	✓
	H140 GC S			✓	
	H140 S	✓	✓	✓	✓
	H160 GC			✓	
	H160 GC S	✓*		✓	✓*
	H160 S			✓	
Multi-Processors	MP324 Concrete Cutter Jaw	✓		✓	✓
	MP324 Demolition Jaw	✓		✓	✓
	MP324 Pulverizer Jaw	✓*		✓	✓*
	MP324 Shear Jaw	✓	✓*	✓	✓
	MP324 Tank Shear Jaw	✓*		✓	✓
	MP324 Universal Jaw	✓		✓	✓
Demolition and Sorting Grapples	G324	✓†		✓†	✓
	G324 WH-1500	✓†*		✓†	✓
	G324 WH			✓†	
	G324 WH			✓†*	
	G332			✓†	✓*
Mobile Scrap and Demolition Shears	S3035 Flat Top			✓*	
Pulverizers	P224 Secondary Pulverizer	✓*		✓	✓*
	P324 Primary Pulverizer	✓*		✓	✓*
Compactors (Vibratory Plate)	CVP110	✓	✓	✓	✓
Rotary Cutters	RC30	✓	✓	✓	✓

(continued on next page)

335 Hydraulic Excavator Specifications

Attachments Offering Guide – North America (continued)

Not all Attachments are available in all regions. Consult your Cat dealer for configurations available in your region.

Match
 Working range front only
 No Match
 † Allowed usage on machine less than 50%

HCS70 DEDICATED COUPLER ATTACHMENTS

		With Blade (Up)		Without Blade	
		5.0 mt (11,020 lb)		7.7 mt (16,980 lb)	
Counterweight		Reach Boom		Reach Boom	
Boom Type		R3.2 (10'6")	R3.75 (12'4")	R3.2 (10'6")	R3.75 (12'4")
Stick Length					
Hydraulic Hammers	H130 S	✓	✓	✓	✓
	H140 S	✓	✓	✓	✓
Multi-Processors	MP324 Concrete Cutter Jaw	✓	✓*	✓	✓
	MP324 Demolition Jaw	✓	✓*	✓	✓
	MP324 Pulverizer Jaw	✓*		✓	✓
	MP324 Shear Jaw	✓	✓*	✓	✓
	MP324 Tank Shear Jaw	✓		✓	✓
	MP324 Universal Jaw	✓		✓	✓
Demolition and Sorting Grapples	G324	✓†	✓*	✓†	✓
	G324 WH-1500	✓†		✓†	✓
	G324 WH-1800			✓†	
	G324 WH-2000			✓†*	
	G332	✓†*		✓†	✓*
Mobile Scrap and Demolition Shears	S3035 Flat Top			✓*	
Pulverizers	P224 Secondary Pulverizer	✓*		✓	✓
	P324 Primary Pulverizer	✓*		✓	✓
Compactors (Vibratory Plate)	CVP110	✓	✓	✓	✓
Rotary Cutters	RC30	✓	✓	✓	✓

(continued on next page)

335 Hydraulic Excavator Specifications

Attachments Offering Guide – North America (continued)

Not all Attachments are available in all regions. Consult your Cat dealer for configurations available in your region.

Match
 Working range front only
 No Match
 † Allowed usage on machine less than 50%

HCS70/55 DEDICATED COUPLER ATTACHMENTS

		With Blade (Up)		Without Blade	
Counterweight		5.0 mt (11,020 lb)		7.7 mt (16,980 lb)	
Boom Type		Reach Boom		Reach Boom	
Stick Length		R3.2 (10'6")	R3.75 (12'4")	R3.2 (10'6")	R3.75 (12'4")
Hydraulic Hammers	H130 S	✓	✓	✓	✓
	H140 S	✓	✓	✓	✓
Multi-Processors	MP324 Concrete Cutter Jaw	✓		✓	✓
	MP324 Demolition Jaw	✓		✓	✓
	MP324 Pulverizer Jaw	✓*		✓	✓*
	MP324 Shear Jaw	✓	✓*	✓	✓
	MP324 Tank Shear Jaw	✓*		✓	✓
	MP324 Universal Jaw	✓		✓	✓
Demolition and Sorting Grapples	G324	✓†		✓†	✓
	G324 WH-1500	✓†*		✓†	✓
	G324 WH-1800			✓†	
	G324 WH-2000			✓†*	
	G332			✓†	✓*
Mobile Scrap and Demolition Shears	S3035 Flat Top			✓*	
Pulverizers	P224 Secondary Pulverizer	✓*		✓	✓*
	P324 Primary Pulverizer	✓*		✓	✓*
Compactors (Vibratory Plate)	CVP110	✓	✓	✓	✓
Rotary Cutters	RC30	✓	✓	✓	✓

(continued on next page)

335 Hydraulic Excavator Specifications

Attachments Offering Guide – North America (continued)

Not all Attachments are available in all regions. Consult your Cat dealer for configurations available in your region.

Match
 Working range front only
 No Match
 † Allowed usage on machine less than 50%

HCS80 DEDICATED COUPLER ATTACHMENTS

		With Blade (Up)		Without Blade	
		5.0 mt (11,020 lb)		7.7 mt (16,980 lb)	
Counterweight		Reach Boom		Reach Boom	
Boom Type		R3.2 (10'6")		R3.75 (12'4")	
Stick Length		R3.2 (10'6")		R3.75 (12'4")	
Hydraulic Hammers	H130 S	✓	✓	✓	✓
	H140 S	✓	✓	✓	✓
	H160 S			✓*	
Multi-Processors	MP324 Concrete Cutter Jaw	✓*		✓	✓*
	MP324 Demolition Jaw	✓*		✓	✓*
	MP324 Pulverizer Jaw			✓	✓*
	MP324 Shear Jaw	✓		✓	✓
	MP324 Tank Shear Jaw	✓*		✓	✓*
	MP324 Universal Jaw	✓*		✓	✓*
Demolition and Sorting Grapples	G324	✓†*		✓†	✓
	G324 WH-1500	✓†*		✓†	✓*
	G324 WH-1800			✓†*	
	G332			✓†*	
Pulverizers	P224	✓*		✓	✓*
	P324	✓*		✓	✓*
Compactors (Vibratory Plate)	CVP110	✓	✓	✓	✓
Rotary Cutters	RC30	✓	✓	✓	✓

(continued on next page)

335 Hydraulic Excavator Specifications

Attachments Offering Guide – North America *(continued)*

Not all Attachments are available in all regions. Consult your Cat dealer for configurations available in your region.

Match Working range front only No Match

TRS23 (PIN-ON TOP/S70 BOTTOM) ATTACHMENTS

		With Blade (Up)		Without Blade	
Counterweight		5.0 mt (11,020 lb)		7.7 mt (16,980 lb)	
Boom Type		Reach Boom		Reach Boom	
Stick Length		R3.2 (10'6")	R3.75 (12'4")	R3.2 (10'6")	R3.75 (12'4")
Hydraulic Hammers	H120 S	✓	✓	✓	✓
	H130 S	✓	✓	✓	✓
Compactors (Vibratory Plate)	CVP110	✓	✓	✓	✓

NOTE: Hammer on tiltrotator usage less than 10% of working hours. Refer to your OMM for recommended hydraulic flow requirements.

TRS23 (S70 TOP/S70 BOTTOM) ATTACHMENTS

		With Blade (Up)		Without Blade	
Counterweight		5.0 mt (11,020 lb)		7.7 mt (16,980 lb)	
Boom Type		Reach Boom		Reach Boom	
Stick Length		R3.2 (10'6")	R3.75 (12'4")	R3.2 (10'6")	R3.75 (12'4")
Hydraulic Hammers	H120 S	✓	✓	✓	✓
	H130 S	✓	✓	✓	✓
Compactors (Vibratory Plate)	CVP110	✓	✓	✓	✓

TRS23 (PIN-ON TOP/S80 BOTTOM) ATTACHMENTS

		With Blade (Up)		Without Blade	
Counterweight		5.0 mt (11,020 lb)		7.7 mt (16,980 lb)	
Boom Type		Reach Boom		Reach Boom	
Stick Length		R3.2 (10'6")	R3.75 (12'4")	R3.2 (10'6")	R3.75 (12'4")
Hydraulic Hammers	H120 S	✓	✓	✓	✓
	H130 GC S	✓		✓	✓
	H130 S	✓	✓	✓	✓
Compactors (Vibratory Plate)	CVP110	✓	✓	✓	✓

NOTE: Hammer on tiltrotator usage less than 10% of working hours. Refer to your OMM for recommended hydraulic flow requirements.

TRS23 (S80 TOP/S80 BOTTOM) ATTACHMENTS

		With Blade (Up)		Without Blade	
Counterweight		5.0 mt (11,020 lb)		7.7 mt (16,980 lb)	
Boom Type		Reach Boom		Reach Boom	
Stick Length		R3.2 (10'6")	R3.75 (12'4")	R3.2 (10'6")	R3.75 (12'4")
Hydraulic Hammers	H120 S	✓	✓	✓	✓
	H130 GC S			✓*	
	H130 S	✓		✓	✓
Compactors (Vibratory Plate)	CVP110	✓	✓	✓	✓

(continued on next page)

335 Hydraulic Excavator Specifications

Attachments Offering Guide – North America (continued)

Not all Attachments are available in all regions. Consult your Cat dealer for configurations available in your region.

Match Working range front only No Match

TRS23 (HCS70 TOP/HCS70 BOTTOM) ATTACHMENTS

		With Blade (Up)		Without Blade	
Counterweight		5.0 mt (11,020 lb)		7.7 mt (16,980 lb)	
Boom Type		Reach Boom		Reach Boom	
Stick Length		R3.2 (10'6")	R3.75 (12'4")	R3.2 (10'6")	R3.75 (12'4")
Hydraulic Hammers	H120 S	✓	✓	✓	✓
	H130 S	✓	✓*	✓	✓
Compactors (Vibratory Plate)	CVP110	✓	✓	✓	✓

TRS23 (HCS70/55 TOP/HCS70/55 BOTTOM) ATTACHMENTS

		With Blade (Up)		Without Blade	
Counterweight		5.0 mt (11,020 lb)		7.7 mt (16,980 lb)	
Boom Type		Reach Boom		Reach Boom	
Stick Length		R3.2 (10'6")	R3.75 (12'4")	R3.2 (10'6")	R3.75 (12'4")
Hydraulic Hammers	H120 S	✓	✓	✓	✓
	H130 S	✓		✓	✓
Compactors (Vibratory Plate)	CVP110	✓	✓	✓	✓

TRS23 (HCS80 TOP/HCS80 BOTTOM) ATTACHMENTS

		With Blade (Up)		Without Blade	
Counterweight		5.0 mt (11,020 lb)		7.7 mt (16,980 lb)	
Boom Type		Reach Boom		Reach Boom	
Stick Length		R3.2 (10'6")	R3.75 (12'4")	R3.2 (10'6")	R3.75 (12'4")
Hydraulic Hammers	H120 S	✓		✓	✓
	H130 S	✓*		✓	✓*
Compactors (Vibratory Plate)	CVP110	✓	✓	✓	✓

BOOM-MOUNT ATTACHMENTS

		With Blade (Up)		Without Blade	
Counterweight		5.0 mt (11,020 lb)		7.7 mt (16,980 lb)	
Boom Type		Reach Boom		Reach Boom	
Mobile Scrap and Demolition Shears	S2070	✓		✓	

335 Hydraulic Excavator Specifications

Attachments Offering Guide – Europe

Not all Attachments are available in all regions. Consult your Cat dealer for configurations available in your region.

Match

Working range front only

No Match

PIN-ON ATTACHMENTS

		With Blade (Up)		Without Blade	
		5.0 mt (11,020 lb)		7.7 mt (16,980 lb)	
Counterweight		Reach Boom		Reach Boom	
Boom Type		R3.2 (10'6")	R3.75 (12'4")	R3.2 (10'6")	R3.75 (12'4")
Stick Length					
Hydraulic Hammers	H130 GC S	✓	✓	✓	✓
	H130 S	✓	✓	✓	✓
	H140 GC S	✓	✓*	✓	✓
	H140 S	✓	✓	✓	✓
	H160 GC S	✓	✓	✓	✓
	H160 S	✓	✓*	✓	✓
Multi-Processors	MP324 Concrete Cutter Jaw	✓	✓	✓	✓
	MP324 Demolition Jaw	✓	✓	✓	✓
	MP324 Pulverizer Jaw	✓	✓	✓	✓
	MP324 Shear Jaw	✓	✓	✓	✓
	MP324 Tank Shear Jaw	✓	✓	✓	✓
	MP324 Universal Jaw	✓	✓	✓	✓
	MP332 Concrete Cutter Jaw	✓*		✓	✓*
	MP332 Demolition Jaw	✓*		✓	✓*
	MP332 Pulverizer Jaw			✓	✓*
	MP332 Shear Jaw	✓*		✓	✓*
	MP332 Tank Shear Jaw			✓*	
	MP332 Universal Jaw			✓	✓*
Demolition and Sorting Grapples	G324	✓	✓	✓	✓
	G324 WH-1500	✓	✓	✓	✓
	G324 WH-1800	✓		✓	✓
	G324 WH-2000	✓*		✓	✓*
	G332	✓	✓*	✓	✓
Mobile Scrap and Demolition Shears	S3035 Flat Top	✓*		✓	✓*
Pulverizers	P224 Secondary Pulverizer	✓	✓	✓	✓
	P324 Primary Pulverizer	✓	✓	✓	✓
	P332 Primary Pulverizer	✓*		✓	✓*
Compactors (Vibratory Plate)	CVP110	✓	✓	✓	✓

(continued on next page)

335 Hydraulic Excavator Specifications

Attachments Offering Guide – Europe (continued)

Not all Attachments are available in all regions. Consult your Cat dealer for configurations available in your region.

Match
 No Match
 1800 kg/m³ (3,000 lb/yd³)
 1200 kg/m³ (2,000 lb/yd³)
 600 kg/m³ (1,000 lb/yd³)

PIN-ON ATTACHMENTS (continued)

Counterweight		With Blade (Up)		Without Blade		
		5.0 mt (11,020 lb)		7.7 mt (16,980 lb)		
Boom Type		Reach Boom		Reach Boom		
Stick Length		3.2 m (10'6")	3.75 m (12'4")	3.2 m (10'6")	3.75 m (12'4")	
Orange Peel Grapples	GSH425-750	●	●	●	●	
	GSH425-950	●	●	●	●	
	GSH425-1150	●	○	●	●	
	GSH440-1150	○		●	○	
	GSH440-1550			○		
	GSH525-750	●	●	●	●	
	GSH525-950	●	○	●	●	
	GSH525-1150	○	○	●	○	
	GSV425-600	●	●	●	●	
	GSV425-750	●	●	●	●	
	GSV425-950	●	●	●	●	
	GSV425-1150	●	○	●	●	
	GSV425-1550	◇	◇	◇	◇	
	GSV525-600	●	●	●	●	
	GSV525-750	●	●	●	●	
	GSV525-950	●	○	●	●	
	GSV525-1150	○	○	●	○	
	Hydraulic Transfer Grab	CTV15-1000	●	●	●	●
		CTV15-1200	●	○	●	●
CTV15-1500		○	○	●	○	
CTV15-1700		○		○	○	
CTV15-1900				○		
CTV20-1300		○	○	●	○	
CTV20-1500		○		○	○	
CTV20-1700				○		
CTV20-1900			○			
Rotary Cutters	RC30	✓	✓	✓	✓	

(continued on next page)

335 Hydraulic Excavator Specifications

Attachments Offering Guide – Europe (continued)

Not all Attachments are available in all regions. Consult your Cat dealer for configurations available in your region.

Match
 Working range front only
 No Match
 † Allowed usage on machine less than 50%

CAT PIN GRABBER COUPLER ATTACHMENTS

		With Blade (Up)		Without Blade	
		5.0 mt (11,020 lb)		7.7 mt (16,980 lb)	
Counterweight		Reach Boom		Reach Boom	
Boom Type		R3.2 (10'6")	R3.75 (12'4")	R3.2 (10'6")	R3.75 (12'4")
Stick Length					
Hydraulic Hammers	H130 GC S	✓	✓	✓	✓
	H130 S	✓	✓	✓	✓
	H140 GC S			✓	
	H140 S	✓	✓	✓	✓
	H160 GC S	✓		✓	✓
	H160 S			✓	
Multi-Processors	MP324 Concrete Cutter Jaw	✓		✓	✓
	MP324 Demolition Jaw	✓*		✓	✓
	MP324 Pulverizer Jaw	✓*		✓	✓*
	MP324 Shear Jaw	✓		✓	✓
	MP324 Tank Shear Jaw	✓*		✓	✓*
	MP324 Universal Jaw	✓*		✓	✓*
	MP332 Shear Jaw			✓*	
Demolition and Sorting Grapples	G324	✓†		✓†	✓
	G324 WH-1500	✓†*		✓†	✓*
	G324 WH-1800			✓†*	
	G332			✓†	
Mobile Scrap and Demolition Shears	S3035 Flat Top			✓*	
Compactors (Vibratory Plate)	CVP110	✓	✓	✓	✓
Rotary Cutters	RC30	✓	✓	✓	✓

(continued on next page)

335 Hydraulic Excavator Specifications

Attachments Offering Guide – Europe (continued)

Not all Attachments are available in all regions. Consult your Cat dealer for configurations available in your region.

Match
 Working range front only
 No Match
 † Allowed usage on machine less than 50%

CW-45s DEDICATED COUPLER ATTACHMENTS

		With Blade (Up)		Without Blade	
		5.0 mt (11,020 lb)		7.7 mt (16,980 lb)	
Counterweight		Reach Boom		Reach Boom	
Boom Type		R3.2 (10'6")	R3.75 (12'4")	R3.2 (10'6")	R3.75 (12'4")
Stick Length					
Hydraulic Hammers	H130 GC S	✓	✓	✓	✓
	H130 S	✓	✓	✓	✓
	H140 GC S			✓*	
	H140 S	✓	✓	✓	✓
	H160 GC S	✓*		✓	✓*
	H160 S			✓*	
Multi-Processors	MP324 Concrete Cutter Jaw	✓		✓	✓
	MP324 Demolition Jaw	✓		✓	✓
	MP324 Pulverizer Jaw	✓*		✓	✓*
	MP324 Shear Jaw	✓	✓*	✓	✓
	MP324 Tank Shear Jaw	✓		✓	✓
	MP324 Universal Jaw	✓		✓	✓
	MP332 Concrete Cutter Jaw			✓*	
	MP332 Shear Jaw			✓*	
Demolition and Sorting Grapples	G324	✓†	✓*	✓†	✓
	G324 WH-1500	✓†*		✓†	✓
	G324 WH-1800			✓†	
	G324 WH-2000			✓†*	
	G332			✓†	✓*
Mobile Scrap and Demolition Shears	S3035 Flat Top			✓*	
Pulverizers	P224 Secondary Pulverizer	✓*		✓	✓*
	P324 Primary Pulverizer	✓*		✓	✓*
Compactors (Vibratory Plate)	CVP110	✓	✓	✓	✓
Rotary Cutters	RC30	✓	✓	✓	✓

(continued on next page)

335 Hydraulic Excavator Specifications

Attachments Offering Guide – Europe (continued)

Not all Attachments are available in all regions. Consult your Cat dealer for configurations available in your region.

Match
 Working range front only
 No Match
 † Allowed usage on machine less than 50%

CW-45 DEDICATED COUPLER ATTACHMENTS

		With Blade (Up)		Without Blade	
		5.0 mt (11,020 lb)		7.7 mt (16,980 lb)	
Counterweight		Reach Boom		Reach Boom	
Boom Type		R3.2 (10'6")	R3.75 (12'4")	R3.2 (10'6")	R3.75 (12'4")
Stick Length					
Hydraulic Hammers	H130 GC S	✓	✓	✓	✓
	H130 S	✓	✓	✓	✓
	H140 GC S			✓	
	H140 S	✓	✓	✓	✓
	H160 GC S	✓*		✓	✓*
	H160 S			✓*	
Multi-Processors	MP324 Concrete Cutter Jaw	✓		✓	✓
	MP324 Demolition Jaw	✓		✓	✓
	MP324 Pulverizer Jaw	✓*		✓	✓*
	MP324 Shear Jaw	✓		✓	✓
	MP324 Tank Shear Jaw	✓*		✓	✓*
	MP324 Universal Jaw	✓*		✓	✓*
	MP332 Concrete Cutter Jaw			✓*	
MP332 Shear Jaw			✓*		
Demolition and Sorting Grapples	G324	✓†		✓†	✓
	G324 WH-1500	✓†*		✓†	✓*
	G324 WH-1800			✓†*	
	G324 WH-1500			✓†*	✓*
	G324 WH-2000			✓†*	
	G332			✓†	
Mobile Scrap and Demolition Shears	S3035 Flat Top			✓*	
Pulverizers	P224 Secondary Pulverizer	✓*		✓	✓*
	P324 Primary Pulverizer	✓*		✓	✓*
Compactors (Vibratory Plate)	CVP110	✓	✓	✓	✓
Rotary Cutters	RC30	✓	✓	✓	✓

(continued on next page)

335 Hydraulic Excavator Specifications

Attachments Offering Guide – Europe (continued)

Not all Attachments are available in all regions. Consult your Cat dealer for configurations available in your region.

Match
 Working range front only
 No Match
 † Allowed usage on machine less than 50%

S70 DEDICATED COUPLER ATTACHMENTS

		With Blade (Up)		Without Blade	
		5.0 mt (11,020 lb)		7.7 mt (16,980 lb)	
Counterweight		Reach Boom		Reach Boom	
Boom Type		R3.2 (10'6")	R3.75 (12'4")	R3.2 (10'6")	R3.75 (12'4")
Stick Length					
Hydraulic Hammers	H130 S	✓	✓	✓	✓
	H140 S	✓	✓	✓	✓
Multi-Processors	MP324 Concrete Cutter Jaw	✓	✓*	✓	✓
	MP324 Demolition Jaw	✓	✓*	✓	✓
	MP324 Pulverizer Jaw	✓		✓	✓
	MP324 Shear Jaw	✓	✓	✓	✓
	MP324 Tank Shear Jaw	✓	✓*	✓	✓
	MP324 Universal Jaw	✓	✓*	✓	✓
Demolition and Sorting Grapples	G324	✓†	✓*	✓†	✓
	G324 WH-1500	✓†	✓*	✓†	✓
	G324 WH-1800	✓†*		✓†	✓*
	G324 WH-2000			✓†	
	G332	✓†*		✓†	✓*
Mobile Scrap and Demolition Shears	S3035 Flat Top			✓	
Pulverizers	P224 Secondary Pulverizer	✓	✓*	✓	✓
	P324 Primary Pulverizer	✓	✓*	✓	✓
Compactors (Vibratory Plate)	CVP110	✓	✓	✓	✓
Rotary Cutters	RC30	✓	✓	✓	✓

(continued on next page)

335 Hydraulic Excavator Specifications

Attachments Offering Guide – Europe (continued)

Not all Attachments are available in all regions. Consult your Cat dealer for configurations available in your region.

Match
 Working range front only
 No Match
 † Allowed usage on machine less than 50%

S80 DEDICATED COUPLER ATTACHMENTS

		With Blade		Without Blade	
		5.0 mt (11,020 lb)		7.7 mt (16,980 lb)	
Counterweight		Reach Boom		Reach Boom	
Boom Type		R3.2 (10'6")	R3.75 (12'4")	R3.2 (10'6")	R3.75 (12'4")
Stick Length		R3.2 (10'6")	R3.75 (12'4")	R3.2 (10'6")	R3.75 (12'4")
Hydraulic Hammers	H130 GC S	✓	✓	✓	✓
	H130 S	✓	✓	✓	✓
	H140 GC S			✓	
	H140 S	✓	✓	✓	✓
	H160 GC S	✓*		✓	✓*
	H160 S			✓*	
Multi-Processors	MP324 Concrete Cutter Jaw	✓		✓	✓
	MP324 Demolition Jaw	✓		✓	✓
	MP324 Pulverizer Jaw	✓*		✓	✓*
	MP324 Shear Jaw	✓	✓*	✓	✓
	MP324 Tank Shear Jaw	✓*		✓	✓
	MP324 Universal Jaw	✓		✓	✓
Demolition and Sorting Grapples	G324	✓†		✓†	✓
	G324 WH-1500	✓†*		✓†	✓
	G324 WH-1800			✓†	
	G324 WH-2000			✓†*	
	G332			✓†	✓*
Mobile Scrap and Demolition Shears	S3035 Flat Top			✓*	
Pulverizers	P224 Secondary Pulverizer	✓*		✓	✓*
	P324 Primary Pulverizer	✓*		✓	✓*
Compactors (Vibratory Plate)	CVP110	✓	✓	✓	✓
Rotary Cutters	RC30	✓	✓	✓	✓

(continued on next page)

335 Hydraulic Excavator Specifications

Attachments Offering Guide – Europe (continued)

Not all Attachments are available in all regions. Consult your Cat dealer for configurations available in your region.

Match
 Working range front only
 No Match
 † Allowed usage on machine less than 50%

HCS70 DEDICATED COUPLER ATTACHMENTS

		With Blade (Up)		Without Blade	
		5.0 mt (11,020 lb)		7.7 mt (16,980 lb)	
Counterweight		Reach Boom		Reach Boom	
Boom Type		R3.2 (10'6")	R3.75 (12'4")	R3.2 (10'6")	R3.75 (12'4")
Stick Length					
Hydraulic Hammers	H130 S	✓	✓	✓	✓
	H140 S	✓	✓	✓	✓
Multi-Processors	MP324 Concrete Cutter Jaw	✓	✓*	✓	✓
	MP324 Demolition Jaw	✓	✓*	✓	✓
	MP324 Pulverizer Jaw	✓*		✓	✓
	MP324 Shear Jaw	✓	✓*	✓	✓
	MP324 Tank Shear Jaw	✓		✓	✓
	MP324 Universal Jaw	✓		✓	✓
Demolition and Sorting Grapples	G324	✓†	✓*	✓†	✓
	G324 WH-1500	✓†		✓†	✓
	G324 WH-1800			✓†	
	G324 WH-2000			✓†*	
	G332	✓†*		✓†	✓*
Mobile Scrap and Demolition Shears	S3035 Flat Top			✓*	
Pulverizers	P224 Secondary Pulverizer	✓*		✓	✓
	P324 Primary Pulverizer	✓*		✓	✓
Compactors (Vibratory Plate)	CVP110	✓	✓	✓	✓
Rotary Cutters	RC30	✓	✓	✓	✓

(continued on next page)

335 Hydraulic Excavator Specifications

Attachments Offering Guide – Europe (continued)

Not all Attachments are available in all regions. Consult your Cat dealer for configurations available in your region.

Match
 Working range front only
 No Match
 † Allowed usage on machine less than 50%

HCS70/55 DEDICATED COUPLER ATTACHMENTS

		With Blade (Up)		Without Blade	
		5.0 mt (11,020 lb)		7.7 mt (16,980 lb)	
Counterweight		Reach Boom		Reach Boom	
Boom Type		R3.2 (10'6")	R3.75 (12'4")	R3.2 (10'6")	R3.75 (12'4")
Stick Length					
Hydraulic Hammers	H130 S	✓	✓	✓	✓
	H140 S	✓	✓	✓	✓
Multi-Processors	MP324 Concrete Cutter Jaw	✓		✓	✓
	MP324 Demolition Jaw	✓		✓	✓
	MP324 Pulverizer Jaw	✓*		✓	✓*
	MP324 Shear Jaw	✓	✓*	✓	✓
	MP324 Tank Shear Jaw	✓*		✓	✓
	MP324 Universal Jaw	✓		✓	✓
Demolition and Sorting Grapples	G324	✓†		✓†	✓
	G324 WH-1500	✓†*		✓†	✓
	G324 WH-1800			✓†	
	G324 WH-2000			✓†*	
	G332			✓†	✓*
Mobile Scrap and Demolition Shears	S3035 Flat Top			✓*	
Pulverizers	P224 Secondary Pulverizer	✓*		✓	✓*
	P324 Primary Pulverizer	✓*		✓	✓*
Compactors (Vibratory Plate)	CVP110	✓	✓	✓	✓
Rotary Cutters	RC30	✓	✓	✓	✓

(continued on next page)

335 Hydraulic Excavator Specifications

Attachments Offering Guide – Europe (continued)

Not all Attachments are available in all regions. Consult your Cat dealer for configurations available in your region.

Match
 Working range front only
 No Match
 † Allowed usage on machine less than 50%

HCS80 DEDICATED COUPLER ATTACHMENTS

		With Blade (Up)		Without Blade	
Counterweight		5.0 mt (11,020 lb)		7.7 mt (16,980 lb)	
Boom Type		Reach Boom		Reach Boom	
Stick Length		R3.2 (10'6")	R3.75 (12'4")	R3.2 (10'6")	R3.75 (12'4")
Hydraulic Hammers	H130 S	✓	✓	✓	✓
	H140 S	✓	✓	✓	✓
	H160 S			✓*	
Multi-Processors	MP324 Concrete Cutter Jaw	✓*		✓	✓*
	MP324 Demolition Jaw	✓*		✓	✓*
	MP324 Pulverizer Jaw			✓	✓*
	MP324 Shear Jaw	✓		✓	✓
	MP324 Tank Shear Jaw	✓*		✓	✓*
	MP324 Universal Jaw	✓*		✓	✓*
Demolition and Sorting Grapples	G324	✓†*		✓†	✓
	G324 WH-1500	✓†*		✓†	✓*
	G324 WH-1800			✓†*	
	G332			✓†*	
Pulverizers	P224 Secondary Pulverizer	✓*		✓	✓*
	P324 Primary Pulverizer	✓*		✓	✓*
Compactors (Vibratory Plate)	CVP110	✓	✓	✓	✓
Rotary Cutters	RC30	✓	✓	✓	✓

(continued on next page)

335 Hydraulic Excavator Specifications

Attachments Offering Guide – Europe (continued)

Not all Attachments are available in all regions. Consult your Cat dealer for configurations available in your region.

Match Working range front only No Match

TRS23 (PIN-ON TOP/CW-40 BOTTOM) ATTACHMENTS

		With Blade (Up)		Without Blade	
Counterweight		5.0 mt (11,020 lb)		7.7 mt (16,980 lb)	
Boom Type		Reach Boom		Reach Boom	
Stick Length		R3.2 (10'6")	R3.75 (12'4")	R3.2 (10'6")	R3.75 (12'4")
Hydraulic Hammers	H120 S	✓	✓	✓	✓
	H130 GC S	✓		✓	✓
	H130 S	✓	✓	✓	✓
Compactors (Vibratory Plate)	CVP110	✓	✓	✓	✓

NOTE: Hammer on tiltrotator usage less than 10% of working hours. Refer to your OMM for recommended hydraulic flow requirements.

TRS23 (CW-40 TOP/CW-40 BOTTOM) ATTACHMENTS

		With Blade (Up)		Without Blade	
Counterweight		5.0 mt (11,020 lb)		7.7 mt (16,980 lb)	
Boom Type		Reach Boom		Reach Boom	
Stick Length		R3.2 (10'6")	R3.75 (12'4")	R3.2 (10'6")	R3.75 (12'4")
Compactors (Vibratory Plate)	CVP110	✓	✓	✓	✓

NOTE: Hammer on tiltrotator usage less than 10% of working hours. Refer to your OMM for recommended hydraulic flow requirements.

TRS23 (PIN-ON TOP/CW-45s BOTTOM) ATTACHMENTS

		With Blade (Up)		Without Blade	
Counterweight		5.0 mt (11,020 lb)		7.7 mt (16,980 lb)	
Boom Type		Reach Boom		Reach Boom	
Stick Length		R3.2 (10'6")	R3.75 (12'4")	R3.2 (10'6")	R3.75 (12'4")
Hydraulic Hammers	H120 S	✓	✓	✓	✓
	H130 GC S	✓*		✓	✓*
	H130 S	✓	✓*	✓	✓
Compactors (Vibratory Plate)	CVP110	✓	✓	✓	✓

NOTE: Hammer on tiltrotator usage less than 10% of working hours. Refer to your OMM for recommended hydraulic flow requirements.

TRS23 (CW-45s TOP/CW-45s BOTTOM) ATTACHMENTS

		With Blade (Up)		Without Blade	
Counterweight		5.0 mt (11,020 lb)		7.7 mt (16,980 lb)	
Boom Type		Reach Boom		Reach Boom	
Stick Length		R3.2 (10'6")	R3.75 (12'4")	R3.2 (10'6")	R3.75 (12'4")
Hydraulic Hammers	H120 S	✓	✓*	✓	✓
	H130 S	✓*		✓	✓*
Compactors (Vibratory Plate)	CVP110	✓	✓	✓	✓

NOTE: Hammer on tiltrotator usage less than 10% of working hours. Refer to your OMM for recommended hydraulic flow requirements.

(continued on next page)

335 Hydraulic Excavator Specifications

Attachments Offering Guide – Europe (continued)

Not all Attachments are available in all regions. Consult your Cat dealer for configurations available in your region.

Match Working range front only No Match

TRS23 (PIN-ON TOP/S70 BOTTOM) ATTACHMENTS

		With Blade (Up)		Without Blade	
Counterweight		5.0 mt (11,020 lb)		7.7 mt (16,980 lb)	
Boom Type		Reach Boom		Reach Boom	
Stick Length		R3.2 (10'6")	R3.75 (12'4")	R3.2 (10'6")	R3.75 (12'4")
Hydraulic Hammers	H120 S	✓	✓	✓	✓
	H130 S	✓	✓	✓	✓
Compactors (Vibratory Plate)	CVP110	✓	✓	✓	✓

NOTE: Hammer on tiltrotator usage less than 10% of working hours. Refer to your OMM for recommended hydraulic flow requirements.

TRS23 (S70 TOP/S70 BOTTOM) ATTACHMENTS

		With Blade (Up)		Without Blade	
Counterweight		5.0 mt (11,020 lb)		7.7 mt (16,980 lb)	
Boom Type		Reach Boom		Reach Boom	
Stick Length		R3.2 (10'6")	R3.75 (12'4")	R3.2 (10'6")	R3.75 (12'4")
Hydraulic Hammers	H120 S	✓	✓	✓	✓
	H130 S	✓	✓	✓	✓
Compactors (Vibratory Plate)	CVP110	✓	✓	✓	✓

NOTE: Hammer on tiltrotator usage less than 10% of working hours. Refer to your OMM for recommended hydraulic flow requirements.

TRS23 (PIN-ON TOP/S80 BOTTOM) ATTACHMENTS

		With Blade (Up)		Without Blade	
Counterweight		5.0 mt (11,020 lb)		7.7 mt (16,980 lb)	
Boom Type		Reach Boom		Reach Boom	
Stick Length		R3.2 (10'6")	R3.75 (12'4")	R3.2 (10'6")	R3.75 (12'4")
Hydraulic Hammers	H120 S	✓	✓	✓	✓
	H130 GC S	✓		✓	✓
	H130 S	✓	✓	✓	✓
Compactors (Vibratory Plate)	CVP110	✓	✓	✓	✓

NOTE: Hammer on tiltrotator usage less than 10% of working hours. Refer to your OMM for recommended hydraulic flow requirements.

TRS23 (S80 TOP/S80 BOTTOM) ATTACHMENTS

		With Blade (Up)		Without Blade	
Counterweight		5.0 mt (11,020 lb)		7.7 mt (16,980 lb)	
Boom Type		Reach Boom		Reach Boom	
Stick Length		R3.2 (10'6")	R3.75 (12'4")	R3.2 (10'6")	R3.75 (12'4")
Hydraulic Hammers	H120 S	✓	✓	✓	✓
	H130 GC S			✓*	
	H130 S	✓		✓	✓
Compactors (Vibratory Plate)	CVP110	✓	✓	✓	✓

NOTE: Hammer on tiltrotator usage less than 10% of working hours. Refer to your OMM for recommended hydraulic flow requirements.

(continued on next page)

335 Hydraulic Excavator Specifications

Attachments Offering Guide – Europe (continued)

Not all Attachments are available in all regions. Consult your Cat dealer for configurations available in your region.

Match Working range front only No Match

TRS23 (HCS70 TOP/HCS70 BOTTOM) ATTACHMENTS

		With Blade (Up)		Without Blade	
Counterweight		5.0 mt (11,020 lb)		7.7 mt (16,980 lb)	
Boom Type		Reach Boom		Reach Boom	
Stick Length		R3.2 (10'6")	R3.75 (12'4")	R3.2 (10'6")	R3.75 (12'4")
Hydraulic Hammers	H120 S	✓	✓	✓	✓
	H130 S	✓	✓*	✓	✓
Compactors (Vibratory Plate)	CVP110	✓	✓	✓	✓

NOTE: Hammer on tiltrotator usage less than 10% of working hours. Refer to your OMM for recommended hydraulic flow requirements.

TRS23 (HCS70/55 TOP/HCS70/55 BOTTOM) ATTACHMENTS

		With Blade (Up)		Without Blade	
Counterweight		5.0 mt (11,020 lb)		7.7 mt (16,980 lb)	
Boom Type		Reach Boom		Reach Boom	
Stick Length		R3.2 (10'6")	R3.75 (12'4")	R3.2 (10'6")	R3.75 (12'4")
Hydraulic Hammers	H120 S	✓	✓	✓	✓
	H130 S	✓		✓	✓
Compactors (Vibratory Plate)	CVP110	✓	✓	✓	✓

NOTE: Hammer on tiltrotator usage less than 10% of working hours. Refer to your OMM for recommended hydraulic flow requirements.

TRS23 (HCS80 TOP/HCS80 BOTTOM) ATTACHMENTS

		With Blade (Up)		Without Blade	
Counterweight		5.0 mt (11,020 lb)		7.7 mt (16,980 lb)	
Boom Type		Reach Boom		Reach Boom	
Stick Length		R3.2 (10'6")	R3.75 (12'4")	R3.2 (10'6")	R3.75 (12'4")
Hydraulic Hammers	H120 S	✓		✓	✓
	H130 S	✓*		✓	✓*
Compactors (Vibratory Plate)	CVP110	✓	✓	✓	✓

NOTE: Hammer on tiltrotator usage less than 10% of working hours. Refer to your OMM for recommended hydraulic flow requirements.

BOOM-MOUNT ATTACHMENTS

		With Blade (Up)		Without Blade	
Counterweight		5.0 mt (11,020 lb)		7.7 mt (16,980 lb)	
Boom Type		Reach Boom		Reach Boom	
Mobile Scrap and Demolition Shears	S2070	✓		✓	

335 Hydraulic Excavator Specifications

Attachments Offering Guide – Australia and New Zealand

Not all Attachments are available in all regions. Consult your Cat dealer for configurations available in your region.

Match
 Working range front only
 No Match
 † Allowed usage on machine less than 50%

PIN-ON ATTACHMENTS

		With Blade (Up)		Without Blade	
Counterweight		5.0 mt (11,020 lb)		7.7 mt (16,980 lb)	
Boom Type		Reach Boom		Reach Boom	
Stick Length		R3.2 (10'6")	R3.75 (12'4")	R3.2 (10'6")	R3.75 (12'4")
Hydraulic Hammers	H130 GC	✓	✓	✓	✓
	H130 GC S	✓	✓	✓	✓
	H130 S	✓	✓	✓	✓
	H140 GC	✓	✓	✓	✓
	H140 GC S	✓	✓*	✓	✓
	H140 S	✓	✓	✓	✓
	H160 GC	✓	✓*	✓	✓
	H160 GC S	✓	✓	✓	✓
	H160 S	✓	✓*	✓	✓
Demolition and Sorting Grapples	G324	✓	✓	✓	✓
	G332	✓	✓*	✓	✓
Mobile Scrap and Demolition Shears	S3035 Flat Top	✓*		✓	✓*
Compactors (Vibratory Plate)	CVP110	✓	✓	✓	✓
Mulchers	HM5515	✓	✓	✓	✓
Rotary Cutters	RC30	✓	✓	✓	✓

CAT PIN GRABBER COUPLER ATTACHMENTS

		With Blade (Up)		Without Blade	
Counterweight		5.0 mt (11,020 lb)		7.7 mt (16,980 lb)	
Boom Type		Reach Boom		Reach Boom	
Stick Length		R3.2 (10'6")	R3.75 (12'4")	R3.2 (10'6")	R3.75 (12'4")
Hydraulic Hammers	H130 GC	✓	✓	✓	✓
	H130 GC S	✓	✓	✓	✓
	H130 S	✓	✓	✓	✓
	H140 GC	✓*		✓	✓*
	H140 GC S			✓	
	H140 S	✓	✓	✓	✓
	H160 GC			✓	✓*
	H160 GC S	✓		✓	✓
	H160 S			✓	
Demolition and Sorting Grapples	G324	✓†		✓†	✓
	G332			✓†	
Mobile Scrap and Demolition Shears	S3035 Flat Top			✓*	
Compactors (Vibratory Plate)	CVP110	✓	✓	✓	✓
Mulchers	HM5515 Standard	✓	✓	✓	✓
Rotary Cutters	RC30	✓	✓	✓	✓

(continued on next page)

335 Hydraulic Excavator Specifications

Attachments Offering Guide – Australia and New Zealand (continued)

Not all Attachments are available in all regions. Consult your Cat dealer for configurations available in your region.

Match No Match

TRS23 (PIN-ON TOP/S70 BOTTOM) ATTACHMENTS

		With Blade (Up)		Without Blade	
Counterweight		5.0 mt (11,020 lb)		7.7 mt (16,980 lb)	
Boom Type		Reach Boom		Reach Boom	
Stick Length		R3.2 (10'6")	R3.75 (12'4")	R3.2 (10'6")	R3.75 (12'4")
Hydraulic Hammers	H120 S	✓	✓	✓	✓
	H130 S	✓	✓	✓	✓
Compactors (Vibratory Plate)	CVP110	✓	✓	✓	✓

TRS23 (PIN-ON TOP/S80 BOTTOM) ATTACHMENTS

		With Blade (Up)		Without Blade	
Counterweight		5.0 mt (11,020 lb)		7.7 mt (16,980 lb)	
Boom Type		Reach Boom		Reach Boom	
Stick Length		R3.2 (10'6")	R3.75 (12'4")	R3.2 (10'6")	R3.75 (12'4")
Hydraulic Hammers	H120 S	✓	✓	✓	✓
	H130 GC S	✓		✓	✓
	H130 S	✓	✓	✓	✓
Compactors (Vibratory Plate)	CVP110	✓	✓	✓	✓

335 Hydraulic Excavator Specifications

Attachments Offering Guide – Hong Kong and Taiwan

Not all Attachments are available in all regions. Consult your Cat dealer for configurations available in your region.

Match

Working range front only

PIN-ON ATTACHMENTS

		With Blade (Up)		Without Blade	
Counterweight		5.0 mt (11,020 lb)		7.7 mt (16,980 lb)	
Boom Type		Reach Boom		Reach Boom	
Stick Length		R3.2 (10'6")	R3.75 (12'4")	R3.2 (10'6")	R3.75 (12'4")
Hydraulic Hammers	H130 GC	✓	✓	✓	✓
	H130 GC S	✓	✓	✓	✓
	H140 GC	✓	✓	✓	✓
	H140 GC S	✓	✓*	✓	✓
	H160 GC	✓	✓*	✓	✓
	H160 GC S	✓	✓	✓	✓
Rotary Cutters	RC30	✓	✓	✓	✓

Standard and Optional Equipment

Standard and optional equipment may vary. Consult your Cat dealer for details.

	Standard	Optional		Standard	Optional
CAT TECHNOLOGY			ENGINE		
Cat Equipment Management:			Cat® C7.1 twin turbo diesel engine	✓	
– VisionLink®	✓ ¹		Three selectable modes: Power, Smart, Eco	✓	
– VisionLink Productivity		✓ ²	Up to 4600 m (15,090 ft) altitude capability with engine power derate above 3000 m (9,840 ft)	✓	
– Remote Flash	✓		52° C (126° F) high-ambient cooling capacity	✓	
– Remote Troubleshoot	✓		–18° C (0° F) cold start capability	✓	
– Work tool recognition and tracking (PL161)	✓		–32° C (–25° F) cold start capability		✓
– Operator Coaching		✓ ³	1 × 145 Amp dual alternator	✓	
Cat Grade:			Electric fuel priming pump	✓	
– Cat Grade with 2D	✓		Reversible hydraulic cooling fans	✓	
– Cat Grade with 2D with Attachment Ready Option (ARO)		✓	Two-stage fuel filtration system with water separator and indicator	✓	
– Laser catcher		✓	HYDRAULIC SYSTEM		
– Cat Grade with 3D (single or dual GNSS)		✓	SmartBoom™		✓ ⁴
– Compatible with 3D grade systems from Trimble, Topcon, and Leica	✓		Auto Dig Boost	✓	
– Cat Grade 3D Ready		✓	Auto Heavy Lift	✓	
– Cat Grade Connectivity		✓ ²	Electric main control valve	✓	
Cat Assist:			Boom and stick regeneration circuits	✓	
– Grade Assist	✓		Automatic hydraulic oil warm up	✓	
– Boom Assist	✓		Automatic two-speed travel	✓	
– Bucket Assist	✓		Boom and stick drift reduction valve	✓	
– Swing Assist	✓		Hydraulic efficiency monitoring		✓
– Lift Assist	✓		Tandem type electronic main pump	✓	
Cat Payload:			Auxiliary Pump		✓
– On-the-go weighing	✓		Element type main hydraulic filter	✓	
– Semiautomatic calibration	✓				
– Payload/cycle information	✓				
– VisionLink Productivity back office reporting		✓ ²			
Cat Advanced Payload:					
– Daily totals		✓			
– Custom lists		✓			
– Smart weight target		✓			
– E-ticket Integration		✓ ²			
Other:					
Cat Tiltrotator (TRS) integration		✓			

¹Provides core telematics data to manage health, maintenance insights, and condition monitoring. Other plans available for more comprehensive data reporting. Consult your Cat dealer for details.

²VisionLink subscription required. Consult your Cat dealer for details.

³VisionLink subscription required for back office reporting. Consult your Cat dealer for details.

⁴Available in Europe only

(continued on next page)

335 Standard and Optional Equipment

Standard and Optional Equipment *(continued)*

Standard and optional equipment may vary. Consult your Cat dealer for details.

	Standard	Optional		Standard	Optional
BOOM, STICKS AND LINKAGE			ELECTRICAL SYSTEM		
Boom cylinders	✓		Maintenance free batteries	✓	
6.15 m (20'2") Reach boom	✓		LED chassis light, left-hand/right-hand boom lights, cab lights – 1,800 lumens	✓	
3.2 m (10'6") Reach stick		✓	Centralized electrical disconnect switch	✓	
3.75 m (12'4") Reach stick		✓	Programmable time delay working lights after engine shutdown	✓	
Bucket linkage, CB2 family with lifting eye	✓		SERVICE AND MAINTENANCE		
UNDERCARRIAGE AND STRUCTURES			Scheduled Oil Sampling (S·O·S SM) sampling ports	✓	
Grease lubricated track	✓		Grouped location for engine oil and fuel filters	✓	
Tie down points on base frame	✓		Integrated vehicle health management system	✓	
Three-piece segmented track guiding guard	✓		SAFETY AND SECURITY		
Full length track guiding guard		✓	Cat Command (remote control)		✓
Heavy-duty travel motor guards	✓		2D E-Fence:	✓	
Swivel guard		✓	– E-ceiling		
5.0 mt (11,020 lb) counterweight (for use with blade)		✓	– E-floor		
7.7 mt (16,980 lb) counterweight (for use without blade)		✓	– E-swing		
600 mm (24") triple grouser track shoes		✓	– E-wall		
700 mm (28") triple grouser track shoes		✓ ⁵	– E-cab avoidance		
850 mm (33") triple grouser track shoes		✓	Auto hammer stop	✓	
3440 mm (11'3") blade		✓	Rear and right-hand-side view cameras	✓	
3600 mm (11'10") blade		✓	360° visibility		✓
			Right-hand handrail and hand hold	✓	
			Service platform with anti-skid plate and countersunk bolts	✓	
			Swing alarm		✓
			Hydraulic lock out lever neutralizes all controls	✓	
			Lockable disconnect switch	✓	
			Ground level accessible secondary engine shutoff switch in cab	✓	
			Signaling/warning horn	✓	
			Inspection lighting		✓

⁵All regions except North America

Dealer Installed Kits and Attachments

Attachments may vary. Consult your Cat dealer for details.

CAB

- Left Hand (LH)/Right Hand (RH) (two-way) electrical pedal for tool control
- Dual exit rear window kit
- Rain protector plus cab light cover
- Front windshield laminated glass (P5A glass, EU demolition regulation)
- Bluetooth key fob

GUARDS

- OPG (not compatible with cab light cover, rain protector)
- Mesh guard full front (not compatible with cab light cover, rain protector)
- Mesh guard lower half front
- Full protecting vandalism guard

SAFETY AND SECURITY

- 76 mm (3") retractable seat belt
- Cat Detect – People Detection
- Cat Command – Remote control kit

335 Cab Options

Cab Options

	Deluxe	Premium* (two piece windshield)	Premium* (one piece windshield)
ROPS	●	●	●
OPG	○	○	○
High-resolution 254 mm (10") LCD touchscreen monitor	●	●	●
Auto bi-level air conditioner	●	●	●
Jog dial and shortcut keys for monitor control	●	●	●
Keyless push-to-start engine control	●	●	●
Height-adjustable console	●	●	●
Tilt-up left-side console	●	●	●
Heated air-suspension seat	●	X	X
Heated and ventilated air-suspension seat	X	●	●
51 mm (2") seat belt	●	●	●
Monitor integrated Bluetooth radio with USB/Auxiliary ports**	●	X	X
Monitor integrated Bluetooth radio with USB/Auxiliary ports/DAB*	●	●	●
12V DC outlets	●	●	●
Document storage	●	●	●
Overhead storage and rear storage with nets	●	●	●
Beverage holder	●	●	●
Cup holder	●	●	●
Openable two-piece front window	●	●	○
One piece front windshield	X	○	●
Rear window emergency exit	●	●	●
Radial wiper with washer	●	X	X
Parallel wiper	X	●	●
Openable polycarbonate skylight hatch	●	●	X
Laminated roof glass	X	X	●
LED dome light	●	●	●
Floor welcome light	●	●	●
Roof sunscreen	●	●	●
Roller front sunscreen	●	●	●
Roller rear sunscreen	○	●	●
Washable floor mat	●	●	●
Beacon ready	●	●	●
Cat Stick Steer	○	○	○
Auxiliary relay	○	○	○

● Standard ○ Optional X Not available

*Europe only

**All regions except Europe

The following information applies to the machine at the time of final manufacture as configured for sale in the regions covered in this document. The content of this declaration is valid as of the date issued; however, content related to machine features and specifications are subject to change without notice. For additional information, please see the machine's Operation and Maintenance Manual.

For more information on sustainability in action and our progress, please visit <https://www.caterpillar.com/en/company/sustainability>.

Engine

- The Cat® C7.1 engine meets U.S. EPA Tier 4 Final and EU Stage V emission standards.
- Cat diesel engines are required to use ULSD (ultra-low sulfur diesel fuel with 15 ppm of sulfur or less) or ULSD blended with the following lower-carbon intensity fuels** up to:
 - ✓ 20% biodiesel FAME (fatty acid methyl ester)*
 - ✓ 100% renewable diesel, HVO (hydrogenated vegetable oil) and GTL (gas-to-liquid) fuels

Refer to guidelines for successful application. Please consult your Cat dealer or "Caterpillar Machine Fluids Recommendations" (SEBU6250) for details.

**Engines with no aftertreatment devices can use higher blends, up to 100% biodiesel (for use of blends higher than 20% biodiesel, consult your Cat dealer).*

***Tailpipe greenhouse gas emissions from lower-carbon intensity fuels are essentially the same as traditional fuels.*

Air Conditioning System

- The air conditioning system on this machine contains the fluorinated greenhouse gas refrigerant R134a (Global Warming Potential = 1430). The system contains 0.9 kg (1.98 lb) of refrigerant which has a CO₂ equivalent of 1.287 metric tonnes (1.418 tons).

Paint

- Based on best available knowledge, the maximum allowable concentration, measured in parts per million (PPM), of the following heavy metals in paint are:
 - Barium < 0.01%
 - Cadmium < 0.01%
 - Chromium < 0.01%
 - Lead < 0.01%

Sound Performance

ISO 6395:2008 (external) – 104 dB(A)

ISO 6396:2008 (inside cab) – 71 dB(A)

- Hearing protection may be needed when operating with an open operator station and cab (when not properly maintained or doors/windows open) for extended periods or in a noisy environment.

Oils and Fluids

- Caterpillar factory fills with ethylene glycol coolants. Cat Diesel Engine Antifreeze/Coolant (DEAC) and Cat Extended Life Coolant (ELC) can be recycled. Consult your Cat dealer for more information.
- Cat Bio HYDO™ Advanced is an EU Ecolabel approved biodegradable hydraulic oil.
- Additional fluids are likely to be present, please consult the Operations and Maintenance Manual or the Application and Installation guide for complete fluid recommendations and maintenance intervals.

Features and Technology

- The following features and technology may contribute to fuel savings and/or carbon reduction. Features may vary. Consult your Cat dealer for details.
 - Advanced hydraulic systems balance power and efficiency
 - Utilizing Cat technologies can help increase operating efficiencies
 - Smart mode matches machine power to digging requirements automatically
 - Eco mode supports reduced fuel consumption for light applications
 - Programmable high-efficiency cooling fans run only when needed
 - The latest hydraulic oil filter provides longer life with a 3,000-hour replacement interval
 - Remote Flash and Remote Troubleshoot

Recycling

- The materials included in machines are categorized as below with approximate weight percentage. Because of variations of product configurations, the following values in the table may vary.

Material Type	Weight Percentage
Steel	85.02%
Iron	7.33%
Nonferrous Metal	1.83%
Mixed Metal	0.02%
Mixed-Metal and Nonmetal	0.80%
Plastic	1.07%
Rubber	0.16%
Mixed Nonmetallic	0.16%
Fluid	2.11%
Other	1.49%
Uncategorized	0.00%
Total	100%

- A machine with higher recyclability rate will ensure more efficient usage of valuable natural resources and enhance End-of-Life value of the product. According to ISO 16714:2008 (Earthmoving machinery – Recyclability and recoverability – Terminology and calculation method), recyclability rate is defined as percentage by mass (mass fraction in percent) of the new machine potentially able to be recycled, reused, or both.

All parts in the bill of material are first evaluated by component type based on a list of components defined by the ISO 16714:2008 and Japan CEMA (Construction Equipment Manufacturers Association) standards. Remaining parts are further evaluated for recyclability based on material type.

Because of variations of product configurations, the following value in the table may vary.

Recyclability – 98%

For more complete information on Cat products, dealer services, and industry solutions, visit us on the web at www.cat.com

© 2024 Caterpillar
All rights reserved

Materials and specifications are subject to change without notice. Featured machines in photos may include additional equipment. See your Cat dealer for available options.

CAT, CATERPILLAR, LET'S DO THE WORK, their respective logos, "Caterpillar Corporate Yellow," the "Power Edge" and Cat "Modern Hex" trade dress as well as corporate and product identity used herein, are trademarks of Caterpillar and may not be used without permission. VisionLink is a trademark of Caterpillar Inc., registered in the United States and in other countries.

AEXQ4003-00 (10-2024)
Build Number: 07H
(Aus-NZ, Europe, Hong Kong,
N Am, Taiwan)

